









EVOLUTION OF AIR CONTROL



PRODUCT CATALOG

Valves, TPMS, Tools & Accessories









Vehicles

	motorcycle
	scooter
	bicycle
	car
	van
	truck
	tractor
	earthmover (EM)

Norms

TR	Tire and Rim Association (US)
ETRTO	European Tyre and Rim Technical Organisation

Material

	brass
	aluminum
	steel
	rubber
	plastic
	nickel-plated
	anodized
	zinc-plated
	chrome-plated

Features

	round top valve cap
	long round top valve cap
	plastic valve cap with sealing
	plastic valve cap without sealing
	hexagonal valve cap
	screw driver valve cap
	plastic valve extension cap
	metal valve extension cap
	DS-P valve cap
	V2B valve cap
	hexagon nut
	external hexagon valve base
	highlight flag



09



19



43



75



83



95



101



113



121

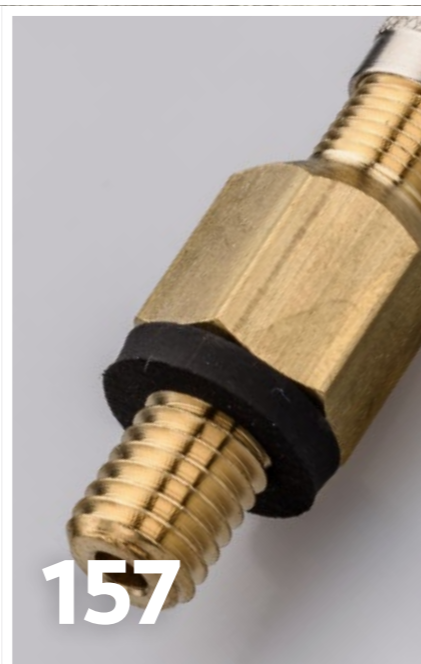

157



131



137

CONTENT

HISTORY	6	TOOLS	114
		Valve mounting tool	118
TPMS	9	Rethreading tools	120
Universal sensor sens.it RS	10	Valve screw driver	121
Sensor valve kits	16	Other tools	123
Starter kits	17	VALVE CAPS	124
Programming and diagnostic tools	18	Car / truck valve caps	126
		Double seal valve caps	131
CAR & VAN VALVES	22	Bicycle valve caps	132
Snap-in rubber valves	25	EM large bore valve caps	133
Metal valves	35	VALVE CORES	134
High-pressure valves	41	Standard valve cores	136
		EM large bore valve cores	139
TRUCK VALVES	46	TIRE FILLING EQUIPMENT	120
TPMS valves	48	Clip-on air chucks	142
Rim valves	50	Clip-on ball foot air chucks	144
Tube valves	64	Thumb-lock air chucks	146
Valve extensions	68	Service station dual foot air chucks	149
		Tire inflators & accessories	157
AGRICULTURAL VALVES	78	SCREW IN VALVES	160
Air/water valves	80	Screw in valves	162
Accessories for agricultural valves	82	Rim ferrule	165
Water filling and emptying devices	83	PART NUMBERS	166
EARTHMOVER VALVES	86		
Large bore valves	88		
Large bore valves with base	90		
Large bore valve extensions	92		
Accessories	95		
MOTORCYCLE VALVES	98		
Valve hole 8.3	100		
Valve hole 11.3	102		
BICYCLE VALVES	104		
Express valve	106		
Universal express valve	108		
Presta valve (Sclaverand)	110		
Air pump valve adapter	111		
Universal service station air chuck	112		
Rotatable tire inflator	114		

HISTORY

1880

In 1880 Margarete Steiff founded her own company in the Swabian town of Giengen, Brenz. With the first Steiff animal, a small elephant made from felt, which was originally intended as a pincushion. She invented the world's first soft toy.



1920



The founding of the ALLIGATOR valve factory in 1920 can also be traced back to the inventive spirit of Richard Steiff: Just in time at the start of the great bicycle boom - at the end of the First World War - Steiff established an industrial mass production for bicycle valves.

1998

ALLIGATOR acquires the EHA Valve Factory W. Fritz Ltd. & Co. EHA was founded as the "First Hanau Precision Screw Factory" which developed and produced the first Snap-in valves with a unique rubberization process.

2019



In 2019, parts of the ALLIGATOR Valves Factory Ltd. was sold to WEGMANN automotive. By selling the factory, the market leader in the field of balancing weights took over the ALLIGATOR brand name, as well as the ALLIGATOR sales and distribution in Europe and North America for both tire valves as well as TPMS sensors and tools.

2009

With ALLIGATOR sens.it, the brand expanded its range with a simple and practical TPMS solution for the aftermarket: Universal TPMS sensors for all vehicle models, that can be programmed just-in-time as a vehicle-specific spare part.

1887

New innovations followed, driven in particular by Margaretes nephew Richard Steiff, who joined the company in 1887, and who created, among other things, the world-famous teddy bear.

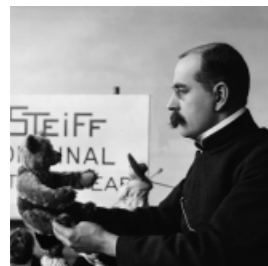

1930

Innovation and tailor-made problemsolving have always been the driving force for ALLIGATOR. For instance, the "ALLIGARO Pump Light" bicycle valve appeared as early as 1930 - the predecessor of the later Blitz valve. High seal quality, low inflation resistance and easy handling distinguished this product from all other available bicycle valves.

2012

ALLIGATOR sens.it wins the Innovation Award with its programmable TPMS sensors.

TODAY

At ALLIGATOR, our customers are main focus of all our actions for more than 100 years. This is why we apply the highest quality standards in the development of our products.

Under the roof of WEGMANN automotive Ltd. over one million ALLIGATOR products are manufactured daily in Europe, which are then sold to customers in more than 60 countries worldwide. The extensive product range covering tire valves and sensor technology offers practical solutions for a variety of applications. All these products have one thing in common: they are optimised for the use and the benefit of the end user and the Workshop.

2020

In 2020, ALLIGATOR celebrates its 100th anniversary.



TPMS



As a long-standing OE supplier of TPMS tire valves, ALLIGATOR has made its business to develop a very simple and practical solution for the TPMS replacement market: the freely programmable sens.it RS universal sensors.

CONTENT

Universal sensor sens.it RS	10
Sensor valve kits	16
Starter kits	17
Programming and diagnostic tools	18

sens.it^{RS}

One sensor for all vehicles

TPMS challenges for the workshop

Increasing number of different TPMS sensors

- High stock levels to guarantee short-term availability.
- Vehicle-specific teach-in procedures are time-consuming and often flawed.
- Service times are getting longer.

Our solution: sens.it RS – the programmable universal sensor

A simple and practical solution for the replacement market

- Only one sensor for all vehicle models.
- Just-in-time programming for vehicle-specific spare parts.
- Program – teach – drive.

Advantages

- **Top coverage:** Vehicle coverage of 98%
- **Short service times:** Standardized assembly without waiting for the right spare part
- **High functionality:** OE quality from ALLIGATOR
- **Less costs:** No software or update costs plus savings on storage and logistics costs



CLICK ME

Video-Tutorial 1: Universal Sensor

In this video we explain the differences between original and universal sensors.



Coverage list

- Listing of all vehicle models covered by sens.it RS sensors.
- Constant adding of new models.
- Coverage list is updated monthly.



To the current coverage list

CLICK ME

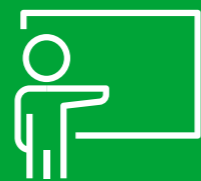

TPMS trainings

ALLIGATOR prepares your employees for TPMS with extensive practical training. Please ask for our TPMS training offers.

E-mail: sens.it@wegmann-automotive.com

Phone: +49 (0) 931 32104 444

TPMS TOOLS FOR THE FUTURE

- Multiple programming of sensors (VT57 & TECH 600)
- High vehicle coverage, including brand/model/year of manufacture
- OBD interface
- Color display and proven menu navigation
- Bluetooth and WiFi
- Wireless updates
- ...and many more functions



ATEQ
VT47

9-590926



ATEQ
VT57

9-590925



Bartec
TECH 350

9-590924



Bartec
TECH 600

9-590923



TPMS FOR ALL VEHICLE MODELS

Professional Starter Kits

For professional use



Tool Bundle VT57

- 1 x programming/diagnostic tool ATEQ VT 57 9-590925
- 24 x universal sensor RS3 9-590914
- 24 x aluminum valve, silver anodized 9-590906
- 1 x operating instructions

Art. no. 9-590939

Tool Bundle VT47

- 1 x programming/diagnostic tool ATEQ VT 57 9-590925
- 12 x universal sensor RS3 9-590914
- 12 x aluminum valve, silver anodized 9-590906
- 1 x operating instructions

Art. no. 9-590941



Tool Bundle Tech600

- 1 x programming/diagnostic tool Bartec Tech 600 9-590923
- 24 x universal sensor RS3 9-590914
- 24 x aluminum valve, silver anodized 9-590906
- 1 x operating instructions

Art. no. 9-590940

Tool Bundle Tech600

- 1 x programming/diagnostic tool Bartec Tech 600 9-590923
- 12 x universal sensor RS3 9-590914
- 12 x aluminum valve, silver anodized 9-590906
- 1 x operating instructions

Art. no. 9-590942

WE SPEAK YOUR LANGUAGE

THE NEW ALLIGATOR *sens.it* RS+ TPMS SENSOR

The all-new RS+ TPMS sensor from Alligator features OEM matched firmwares for 99.7 % of passenger vehicles out on the road. That means when you install it, it's going to work. Every time. No guessing. No issues.



CLICK ME



Aluminum valve, silver

- Qty: 12 sensors, partly assembled
- Mounting: Ball-joint
- Frequency range: 433 MHz
- Valve angle: Adjustable 12-40°
- Valve type: Silver aluminum valve

Art. no. 9-591132



Aluminum valve, black

- Qty: 12 sensors, partly assembled
- Mounting: Ball-joint
- Frequency range: 433 MHz
- Valve angle: Adjustable 12-40°
- Valve type: Black aluminum valve

Art. no. 9-591136



Snap-in rubber valve

- Qty: 12 sensors
- Mounting: Screwing system
- Frequency range: 433 MHz
- Valve angle: Rigid 20°
- Valve type: EPDM snap-in rubber valve

Art. no. 9-591134

TPMS aluminum valves can be found on page 14 (item no.: 9-590906, 9-590904, 9-590908 & 9-030000).

The matching rubber valve has the item number: 9-591320.

99,7% COVERAGE

For universal use: Our sens.it RS+ TPMS sensors speak the language of 99.7% of all vehicles.

99.7

SHORT SERVICE TIMES

without waiting for the right spare part



OE QUALITY

with full OEM functionality, reliable battery & valves made by German engineers.



STANDARDIZED ASSEMBLY



COMPATIBILITY

with all commercially available diagnostic devices & standard valves.



LESS STORAGE COSTS

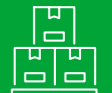

Universal sensor RS3

For metal valves

- **Application:** Suitable for all steel and aluminum wheels
- **Range of functions:** OE quality
- **Sensor-valve connection:** Screw connection with ball-joint



Sensor RS3

Art. no.	Description	Mounting	Frequency range (MHz)	Adjustable angles (°)	Qty	Vehicle type
9-590914	Universal TPMS sensor RS3 (without valve)	Ball-joint	433	12-40	1	

TPMS aluminum valves for RS3

Valve hole 11.3 + 0.4 mm



Art. no.	Color	Mounting	Valve type	Valve length (mm)	Installation torque for bolt and nut (Nm)	Qty	Vehicle type	Surface	Valve cap
9-590906	Silver	Ball-joint	Screw valve	43	3.3	1		Elox	
9-590904	Titanium gray	Ball-joint	Screw valve	43	3.3	1		Elox	
9-590908	Black	Ball-joint	Screw valve	43	3.3	1		Elox	

Maximum working pressure: 14 bar / 200 psi
All valves are supplied with a screw.
Only use with nickel-plated valve core to avoid corrosion!

Spare part

Art. no.	Description
9-030000	Screw M5, Torx TX15

Universal sensor RS4

For snap-in valves

- **Application:** Vehicles with original TPMS rubber valve variant or maximum speeds up to 210 km/h / 130 mph
- **Range of functions:** OE quality
- **Sensor-valve connection:** Clip-pin mechanism



Sensor RS4

Art. no.	Description	Mounting	Frequency range (MHz)	Fixed angle (°)	Qty	Vehicle type
9-590918	Universal TPMS sensor RS4 (without valve)	Clip-pin	433	20	1	

TPMS rubber valve for RS4

Valve hole 11.3 + 0.4 mm



9-590916

Art. no.	Mounting	Valve type	Valve length (mm)	Pressure range (bar/psi)	Qty	Vehicle type	Valve cap
9-590916	Clip pin	Snap-in valve	43	4.5 / 65	1		

Sensor valve kits

Sensor with matching valve

PRE-PROGRAMMED SENSORS

On request we can also deliver the sensors pre-programmed.



Sensor valve kits

For use in the workshop

Art. no.	Description	Qty
9-591122	1x universal sensor RS3 (9-590914) 1x aluminum valve, silver (9-590906)	1
9-591123	1x universal sensor RS3 (9-590914) 1x aluminum valve, black (9-590908)	1
9-591124	1x universal sensor RS4 (9-590918) 1x rubber valve (9-590916)	1

Sensor valve kits in tray packaging

For large purchase quantities



Art. no.	Description	Qty
9-590961	Universal sensor RS3 (9-590914) with pre-assembled silver aluminum valve (9-590906). Nuts are supplied separately.	144 (8 trays x 18 pcs.)
9-591061	Universal sensor RS3 (9-590914) with pre-assembled black aluminum valve (9-590908). Nuts are supplied separately.	144 (8 trays x 18 pcs.)
9-590965	Universal sensor RS4 (9-590918) with pre-assembled snap-in valve (9-590916).	144 (8 trays x 18 pcs.)



To the mounting instructions for TPMS sensors in tray packaging

Starter kits

The perfect start to TPMS service



Tool bundle PT3

- 1x programming/diagnostic tool PT3 9-030229
- 24x universal sensor RS3 9-590914
- 24x aluminum valve, silver anodized 9-590906
- 1x operating instructions

Art. no. 9-590938



Starter kit PT1

- 1x programming tool PT1 9-590922
- 8x universal sensor RS3 9-590914
- 8x aluminum valve, silver anodized 9-590906
- 1x operating instructions

Art. no. 9-590919



Mini starter kit PT1

- 1x programming tool PT1 9-590922
- 4x universal sensor RS3 9-590914
- 4x aluminum valve, silver anodized 9-590906
- 1x operating instructions

Art. no. 9-590933

TPMS programming and diagnostic tool PT3

Wireless and handy

Functions:

- Programming and cloning ALLIGATOR sens.it sensors
- Readout of all TPMS sensors possible
- OBD2 diagnostic module integrated
- Integrated teaching procedure
- Information in 23 languages

Advantages:

- Simple operation: Vehicles selectable by brand, model, and year
- 5 years free sens.it software updates.

Art. no.	Description	Sensor type	Frequency	Cable connection	Housing
9-030229	Programming and diagnostic device PT3	sens.it RS, sens.it ONE	433 MHz	USB	Rubber protective cover



TPMS programming tool PT1

The ideal complement to hand-held TPMS devices

Functions:

- Programming and cloning ALLIGATOR sens.it sensors

Advantages:

- Software guides user intuitively through the programming and teach-in process
- Operating errors are excluded
- Always up-to-date with free software through online connection
- New vehicles are constantly being added to the software

Art. no.	Description	Sensor type	Frequency	Cable connection	Housing
9-590922	Programming device PT1	sens.it RS, sens.it ONE	315 MHz, 433 MHz	USB type A	Rubber protective cover

 To the PT1 operating instructions
[CLICK ME](#)



ALLIGATOR

Diagnostic devices overview



ALLIGATOR part number	9-590925	9-590926
Provider	ATEQ	ATEQ
Device	VT57	VT47
Design	Handy, robust	Compact, robust
Dimensions & Weight	Dimensions: 200x130x50 mm Weight: 650g	Dimensions: 175x108x42 mm Weight: 440g
Languages	Available in 21+ languages	Available in 21+ languages
Finish	Rubberised	Rubberised
Application	Professional device	Entry-level device
Menu navigation	Familiar ATEQ menu navigation	Familiar ATEQ menu navigation
Programming	ALLIGATOR sensors as well as all current sensor manufacturers, copying of sensors, creation of IDs	ALLIGATOR sensors as well as all current sensor manufacturers, copying of sensors, creation of IDs
Display	Relevant sensor data: ■ Pressure ■ Battery status ■ Temperature ■ ID ■ Frequency	Relevant sensor data: ■ Pressure ■ Battery status ■ Temperature ■ ID ■ Frequency
Reading of remote keys	✓	✓
WI-FI/BLUETOOTH	✓	✓
Updates	Wireless	Wireless
Programming process	OBd teach-in, automatic teach-in, manual teach-in	OBd teach-in, automatic teach-in, manual teach-in
Display & Size	4.3" colour touch display	2.8" colour display
OBdII Module	✓	✓
Bundles	✓	-
Bundle content	24 x ALLIGATOR sensors & valves	-
Bundle part number	9-590939	-
Functionality	Programs all leading after-market sensor brands, multiple programming of sensors (where supported), search by brand, model, year of construction via VIN scan, DOT recording, touch screen, functionality of tire profile depth (accessories required), displays OE sensor and service kit part numbers, shows TPMS data for up to 7 tires on one screen, call up/delete RDKS-DTC codes (error memory)	Activates all OEM sensors, displays all sensor data, can reset vehicles both manually and through OBdII retooling, programs all leading after-market sensor brands, displays OE sensor and service kit part numbers, shows TPMS data for up to 7 tires on one screen
Accessories	OBdII module, mains plug, USB cable	OBdII module, mains plug, USB cable
Packaging	Hardcase	Hardcase
Service	ALLIGATOR Service-Hotline	ALLIGATOR Service-Hotline
Update support	3 years free of charge	3 years free of charge
Update extension	+1 year extension available part number 9-030219	+1 year extension available part number 9-030219
PC software	WebVt	WebVt



9-590923	9-590924	9-590926
Bartec	Bartec	ALLIGATOR
Tech 600	Tech 350	PT3
Handy, robust	Compact, robust	Compact, robust
Dimensions: 187x107x47 mm Weight: 375g	Dimensions: 204x100/800x35 mm Weight: 380g	Dimensions: 175x108x42 mm Weight: 400g
Available in 21+ languages	English, French and Spanish	Available in 21+ languages
Rubberised	Ergonomically shaped	Rubberised
Professional device	Entry-level device	Entry-level device
Familiar Bartec menu navigation	Familiar Bartec menu navigation	Familiar ALLIGATOR menu navigation
ALLIGATOR sensors as well as all current sensor manufacturers, copying of sensors, creation of IDs	ALLIGATOR sensors as well as all current sensor manufacturers, copying of sensors, creation of IDs	ALLIGATOR sensors (sens.it RS & One sensors), creation of IDs and copying of only ALLIGATOR sensors
Relevant sensor data: ■ Pressure ■ Battery status ■ Temperature ■ ID ■ Frequency	Relevant sensor data: ■ Pressure ■ Battery status ■ Temperature ■ ID ■ Frequency	Relevant sensor data: ■ Pressure ■ Battery status ■ Temperature ■ ID ■ Frequency
-	-	✓
✓	-	-
Wireless	via USB	via USB
OBd teach-in, automatic teach-in, manual teach-in	OBd teach-in, automatic teach-in, manual teach-in	OBd teach-in, automatic teach-in, manual teach-in
2.8" colour display	2.8" colour display	2.8" colour display
✓	✓	✓
✓	-	✓
24 x ALLIGATOR sensors & valves	-	24 x ALLIGATOR sensors & valves
9-590940	-	9-590938
Multiple programming of several sensors simultaneously, wall mount with integrated Qi inductive charging function + integrated mount for the BT OBd II module, one-handed operation for right-handed/left-handed users, Bluetooth OBd programming module, status LED + buzzer in BT OBdII module - buzzer warns about loss of BT OBdII module in vehicle	Market-leading OBd and other detection features, when first switching on the device the user is guided through device registration and receives access to Bartec's PC-based program - TPMS Desktop - which enables easy and regular software updates, TPMS diagnostics via OBdII, constructed to withstand the environment of the tire workshop	Activates all OEM sensors, displays all sensor data, can reset vehicles both manually and through OBdII retooling, programs all ALLIGATOR sensors, displays OE sensor and service kit part numbers
OBdII module, docking station, mains plug, USB cable	OBdII module, mains plug, USB cable	OBdII module, mains plug, USB cable
Cloth bag	Box	Hardcase
ALLIGATOR Service-Hotline	ALLIGATOR Service-Hotline	ALLIGATOR Service-Hotline
1 year free of charge	1 year free of charge	5 years free of charge (only ALLIGATOR)
+1 year extension available part number 9-030219	+1 year extension available part number 9-030219	+1 year extension possible, no upgrade available for multiple brands, part number 9-030219
TPMS Desktop	TPMS Desktop	WebVt

CAR & VAN VALVES



ALLIGATOR rubber and metal valves are an integral part of the valve world and have been used successfully in the passenger car and van sector for decades.

CONTENT

Snap-in rubber valves	25
Metal valves	35
High-pressure valves	41

ALLIGATOR VALVES

ALWAYS THE RIGHT CHOICE!



Only high-quality materials such as EPDM rubber are used to manufacture the valves. This particular material has a high resistance to ozone, sunlight, and chemicals and thus extends the service life of the valve.

ALLIGATOR offers an extensive range of valves for passenger cars, vans, trucks, motorbikes, scooters, bicycles, tractors, and earthmovers.

In day-to-day business, ALLIGATOR is always there for its customers with advice and support. Information such as assembly instructions are also provided.

SNAP-IN RUBBER VALVES

Flexible and easy to mount

- **Application:** Passenger car, trailer
- **Pressure range:** Up to 4.5 bar / 65 psi
- **Properties:** Elastic valve shaft, easy assembly
- **Fit:** Suitable for ETRTO rims
- **Series:** OE Premium and ALLIGATOR line
- **Proper storage:** Cool and dark, protected from sunlight and ozone.

The ETRTO (European Tyre and Rim Technical Organization) strongly recommends using either metal valves (clamp-in) or valve supports for tubeless tires on passenger cars at speeds >210 km/h in order to limit the valve deflection to a maximum angle of 25°.

Snap-in rubber valves for TPMS applications do not require this support, as they can only be used up to 210 km/h. Unless the valve and vehicle manufacturer has approved it accordingly.

Our valves naturally meet the requirements of the ETRTO standard.



Maximum speeds of rubber valves

Unsupported valve deflection > 25°



Maximum permitted speed: 210 km/h

Supported valve deflection < 25°



Maximum permitted speed: 250 km/h

MOUNTING RUBBER VALVES

Snap-in valves can be installed quickly and professionally

Rims suitable for rubber valves:

- Round, non-oval valve hole with diameter 11.3 -0/+0.4 mm.
- Valve hole must be free of burrs and damage and must comply with ETRTO regulations.
- The rim thickness is min. 1.8 mm and max. 4 mm.



Don't forget the valve cap!
It protects against dirt and corrosion.

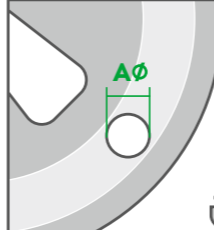

A Ø	B
8,8 mm	TR438
11,3 mm	TR412
	TR413
	TR414(L)
	TR418
	TR600XHP
	TR602XHP
15,7 mm	TR415

When selecting the valve, pay attention to the rim hole diameter.

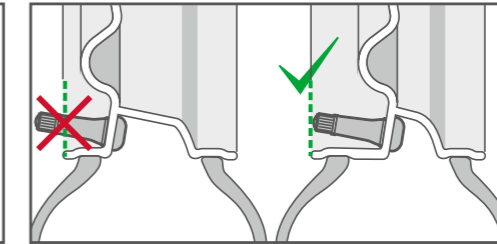

The rim valve must not protrude beyond the outer edge of the rim.

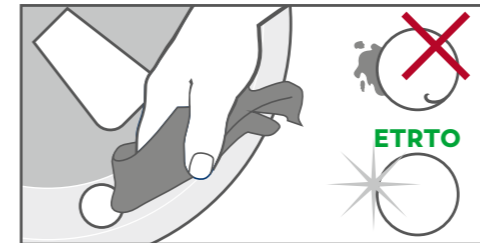

The valve hole must be free of dirt and burrs and comply with ETRTO.



Coat the valve with (soapy) water to facilitate assembly and prevent damage.

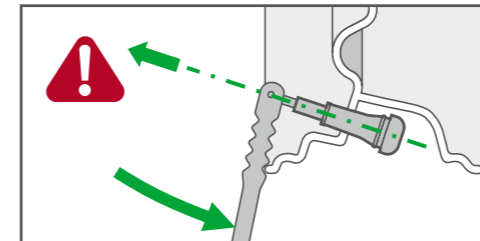

Retract the valve axially without angling it. Do not tilt or overstretch.

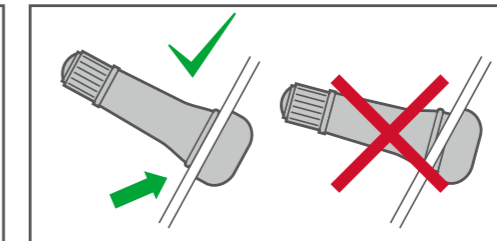

Make sure the valve is well seated in the rim and check the valve for damage.

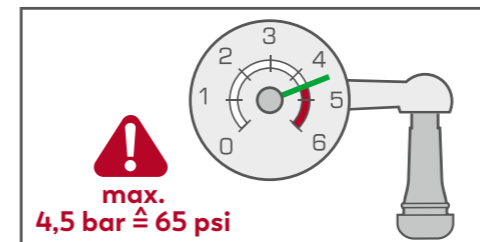

Note

Rubber valves can be used up to a pressure range of 4.5 bar / 65 psi.

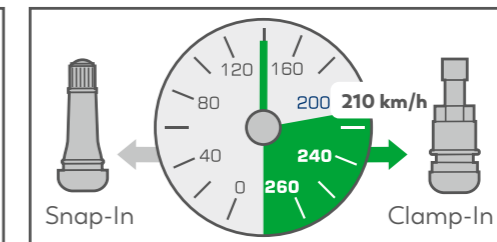

Note

The max. permissible speed for snap-in valves is 210 km/h / 130 mph. For higher speeds (index V, W, Y, ZR), metal valves must be used for safety reasons.

WHY CHANGE VALVES?

Pressure loss due to high stress

What influences is a rubber valve exposed to?

- Brittleness of the rubber due to ozone in the air, heat from the environment and the radiant heat of the brakes
- Corrosion due to the ingress of dirt
- Weight load due to centrifugal forces at high speeds
- Damage due to stone impact or contact with the curb

Replace valves for more safety

- Replace the valve every time you change the tire.
- Look for functional valve caps as protection against dirt, water, and creeping pressure loss.
- Use quality valves from ALLIGATOR – designed for heavy-duty use.

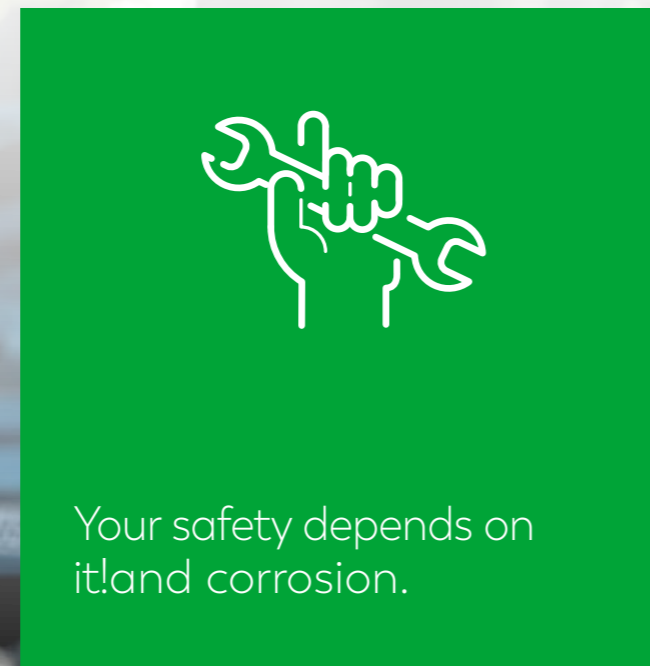

DO NOT OVERLAY RUBBER VALVES

Proper storage and assembly

Instructions for mounting

- **Good and proper lubrication:** Avoid cracks during assembly.
- **Pull in without angular offset:** Pulling in at an angle significantly increases the load and thus the risk of damage to the valve.

Notes on storage

- Do not store valves for extended periods: Use the first-in, first-out method (do not buy in stock).
- Proper storage: Cool and dark, protected from sunlight and ozone, not in the same room with electrical equipment (e.g., compressors) or chemicals.

What happens with incorrect storage

- Incorrect storage accelerates the natural aging of the rubber.
- The elasticity of the rubber decreases.
- Cracks may appear in the clamping area due to the expansion caused during assembly.
- Risk of pressure loss in the tire due to growing cracks or tears in the valve.
- Risk of a flat tire or accident greatly increased.



Old, torn valve

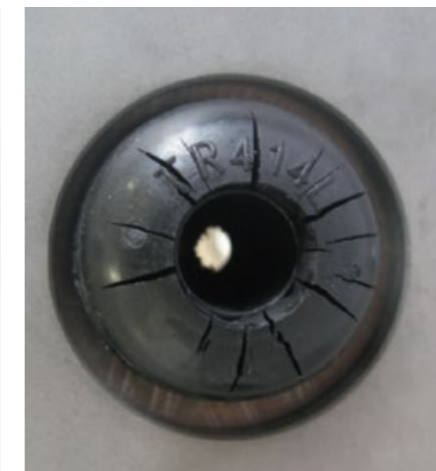

Ozone cracks



Axial drawing in

OE Premium Line

For the highest demands

- **Application:** OE manufacturer (original equipment) / aftermarket
- **Quality checks/standard:** Meets OEM requirements (significantly higher than ETRTO & DIN)
- **Testing:** 100% process monitoring at every step
- **Material:** High-quality, resistant special rubber compound

- **Properties:** High resistance to ozone, UV light, and chemicals
- **Marking on the valve base:** ALLIGATOR + TR41x
- **Laser marking:** Individual marking of rubber valves possible
- **Traceability:** High product traceability



Valve hole 11.3 + 0.4 mm

Art. no.	TR no.	Variant	ETRTO no.	Valve length (mm)	Qty	Vehicle type	Valve caps
9-521515	TR412	mounted	V2.03.6	33	100		
9-521520	TR412	with DS-P cap	V2.03.6	33	20		
9-521527	TR412	unassembled	V2.03.6	33	100		
9-521545	TR412	with metal cap	V2.03.6	33	100		
9-522445	TR413	mounted	V2.03.1	43	100		
9-522032	TR413	partly assembled	V2.03.1	43	100		
9-522018	TR413	unassembled	V2.03.1	43	100		
9-522070	TR413	with extension cap	V2.03.1	43	100		
9-522099	TR413	with metal sleeve	V2.03.1	43	100		
9-522036	TR413	with metal cap	V2.03.1	43	100		
9-523445	TR414	mounted	V2.03.2	49	100		
9-523131	TR414	partly assembled	V2.03.2	49	100		
9-523018	TR414	unassembled	V2.03.2	49	100		
9-523099	TR414	with metal sleeve	V2.03.2	49	100		
9-523036	TR414	with metal cap	V2.03.2	49	100		
9-529445	TR414L	mounted	V2.03.8	56.5	100		
9-525445	TR418	mounted	V2.03.4	61.5	100		
9-525018	TR418	unassembled	V2.03.4	61.5	100		

Valve hole 8.8 + 0.4 mm

Art. no.	TR no.	Variant	Valve length (mm)	Qty	Vehicle type	Valve caps
9-520542	438	Partly assembled with metal cap	41	100		

Valve hole 15.7 + 0.4 mm

Art. no.	TR no.	Variant	ETRTO no.	Valve length (mm)	Qty	Vehicle type	Valve caps
9-524145	415	mounted	V2.03.3	43	100		

Standard Qty: 100 pcs. in bag, 1,000 pcs. in box, 36,000 pcs. on pallet



ALLIGATOR Line

Reliably tested quality

- **Application:** Aftermarket
- **Quality checks/standard:** Complies with the ETRTO standard
- **Testing:** 100% check for function and tightness
- **Material:** High-quality rubber compound

- **Properties:** High ozone, UV light, and chemical resistance
- **Marking on the valve base:** ST-EHA + TR41x
- **Laser marking:** -
- **Traceability:** High traceability via packaging

Valve hole 11.3 + 0.4 mm

Art. no.	TR no.	Variant	ETRTO no.	Valve length (mm)	Qty	Vehicle type	Valve caps
9-529900	TR412	mounted	V2.03.6	33	100		
9-529904	TR412	partly assembled	V2.03.6	33	100		
9-529902	TR412	unassembled	V2.03.6	33	100		
9-529910	TR413	mounted	V2.03.1	43	100		
9-529914	TR413	partly assembled	V2.03.1	43	100		
9-529912	TR413	unassembled	V2.03.1	43	100		
9-529920	TR414	mounted	V2.03.2	49	100		
9-529924	TR414	partly assembled	V2.03.2	49	100		
9-529922	TR414	unassembled	V2.03.2	49	100		
9-529930	TR414L	mounted	V2.03.8	56.5	100		
9-529934	TR414L	partly assembled	V2.03.8	56.5	100		
9-529932	TR414L	unassembled	V2.03.8	56.5	100		
9-529950	TR418	mounted	V2.03.4	61.5	100		
9-529954	TR418	partly assembled	V2.03.4	61.5	100		



Standard Qty: 100 pcs. in bag, 1,000 pcs. in box, 36,000 pcs. on pallet



HIGH PRESSURE AND EXTREME CONDITIONS? NO PROBLEM!

THE ASC SEALING CONCEPT



METAL VALVES

Also for wheels under heavy loads

- **Application:** Passenger cars, vans, campers
- **Pressure range:** Up to 14 bar / 203 psi
- **Properties:** Robust design, high tightness
- **Fit:** Suitable for ETRTO rims
- **Series:** Standard and ASC family valves
- **Proper storage:** Cool and dark, protected from sunlight and ozone.

If the speed exceeds 210 km/h / 130 mph, metal valves (clamp-in) must be used.

Highlights



9-512512

9-512573

9-512563

9-512553

9-512558

9-512568

ASC (Advanced Sealing Concept)

Advanced sealing concept for highly stressed wheels

Sealing concept:

- Tightening forces are introduced directly into the metal of the rim.
- Seal can fulfill its task regardless of external forces.

Advantages:

- High temperature resistance even under extreme conditions.
- Secure sealing.
- Seal adapts to the valve hole.
- No damage to the seal during assembly.
- Firm fit over a long period of use.
- Nut can be mounted with the valve cap screwed on.



9-512512 9-512514 9-512573 9-512583 9-512593

ASC family

Valve hole 11.3+0.4 | brass

Art. no.	Description	Valve length (mm)	Wrench size	Installation torque (Nm)	Qty	Vehicle type	Surface	Valve caps
9-512512	31 MS ASC-HT	31.5	11	4-6	20		Ni	
9-512514	31MS ASC-HT with V2B	31.5	11	4-6	20		Ni	
9-512573	40MS ASC-HT	40	11	4-6	20		Ni	
9-512583	47MS ASC-HT	47	11	4-6	20		Ni	
9-512593	60MS ASC-HT	60	11	4-6	20		Ni	

HT = high temperature



9-516023 9-511983 9-512503 9-512507 9-512563 9-512553
9-512564

9-513103 9-513143 9-512462 9-512628 9-513003

Valve hole 11.3 + 0.4 mm

Brass

Art. no.	Description	TR no.	ETRTO no.	Valve length (mm)	Wrench size	Installation torque (Nm)	Qty	Vehicle type	Surface	Valve caps
9-516023	36MS		V2.04.1 EQ	36	14	3-5	20		Ni	
9-511983	37MS			37	14	3-5	20		Ni	
9-512503	39MS	416S	V2.05.1	39	14	3-5	20		Ni	
9-512507	39MS unmounted	416S	V2.05.1	39	14	3-5			Ni	
9-512563	42MS with plastic washer			42	11	3-5	20		Ni	
9-512553	42MS without plastic disc		V2.05.3	42	11	3-5	20		Ni	
9-512564	42MS without plastic disc		V2.05.3	42	11	3-5	100		Ni	
9-513103	42MS with short nut		V2.05.4	42	14	3-5	20		Ni	
9-513143	42MS with high nut			42	14	3-5	20		Ni	
9-512462	42MS partly assembled			42	14	3-5	500		Ni	
9-512628	43MS			43	14	3-5	20		Ni	
9-513003	45MS (classic car)			45	13	3-5	4		Ni	

Valve hole 11.3 + 0.4 mm
Brass



Art. no.	Description	Valve length (mm)	Wrench size	Qty	Vehicle type	Surface	Valve caps
9-519003	Metal tube valve 43MS	43	17	20		-	



Valve hole 11.3 + 0.4 mm
Aluminum

Art. no.	Description	Valve length (mm)	Wrench size	Installation torque (Nm)	Qty	Vehicle type	Surface	Valve caps
9-513043	34LMS	34	14	4-6	20		-	
9-515003	36LMS	36	14	4-6	20		-	
9-590046	43LMS, silver	43	11	3-5			Elox	
9-512558	43LMS, black	43	11	3-5	20		Elox	
9-512568	43LMS, titanium gray	43	11	3-5	20		Elox	

Only use with nickel-plated valve core to avoid corrosion!

Valve hole 6.3 + 0.4 mm
Brass



Art. no.	Description	Valve length (mm)	Wrench size	Installation torque (Nm)	Qty	Vehicle type	Surface	Valve caps
9-594150	39.5MS Enkie	39.5	11	3-5			Cr	

Valve hole 8.3 + 0.4 mm
Brass



Art. no.	Description	Valve length (mm)	Wrench size	Installation torque (Nm)	Qty	Vehicle type	Surface	Valve caps
9-511992	26MS	26	11	5-7	20		Ni	
9-511003	33MS with two sealing rings	33	10	3-5	20		Ni	
9-511993	39MS with high nut	39	11	5-7	20		Ni	

Spare parts for 9-511003



Art. no.	Description	TR no.	Material	Surface
9-323020	Round washer	RW12EQ	Fe	Zn
9-030731	Sealing ring		Rubber	



9-516103

Valve hole 9.7 + 0.4 mm

Brass

Art. no.	Description	Valve length (mm)	Wrench size	Installation torque (Nm)	Qty	Vehicle type	Surface	Valve caps
9-516103	35MS	35	14	4-6	20		Ni	



9-512013

Valve hole 15.7 + 0.4 mm

Brass

Art. no.	Description	TR no.	ETRTO no.	Valve length (mm)	Wrench size	Installation torque (Nm)	Qty	Vehicle type	Surface	Valve caps
9-512013	40MS	416eq	V2.05.2	40	14	3-5	20		Ni	

HIGH-PRESSURE VALVES

Easy to assemble and pressure resistant

- **Application:** Vans, campers
- **Pressure range:** Up to 7 bar / 102 psi (CVV)
Up to 6.9 bar / 100 psi (TR series)
- **Properties:** Combined rubber-metal valve
- **Fit:** Suitable for ETRTO rims
- **Series:** TR HP/TR XHP and CVV
- **Proper storage:** Cool and dark, protected from sunlight and ozone

- Do not use metal valve extensions on high pressure valves.
- Limit angular deflection to max. 10°

Highlights



9-530020



9-530030

TR high-pressure valves (TR XHP/TR HP)

Standard high-pressure valves

- **Pressure range:** Up to 6.9 bar / 100 psi
- **Properties:** Vulcanized rubber-metal bond

TR HP = TR high-pressure valves
TR XHP = TR extra high-pressure Valves

SMALL DIFFERENCE - BIG EFFECT

TR 600XHP with optimized rubber-metal bond and extra-long metal stem.

- More stability
- Higher pressure resistance



TR XHP

TR HP



9-095519

9-095554

9-521214

Valve hole 11.3 + 0.4 mm

Art. no.	Description	TR no.	ETRTO no.	Valve length (mm)	Pressure range (bar/psi)	Temperature range (°C)	Qty	Vehicle type	Material	Surface	Valve caps
9-095519	TR 600XHP	600HPeq	V3.23.1	43	< 6.9 / 100	-40 / +100	100		CuZn	-	
9-095554	TR 602XHP	602HPeq	V3.23.2	62.1	< 6.9 / 100	-40 / +100	100		CuZn	-	

Valve hole 15.7 + 0.4 mm

Art. no.	Description	TR no.	Valve length (mm)	Pressure range (bar/psi)	Temperature range (°C)	Qty	Vehicle type	Material	Surface	Valve caps
9-521214	TR 801HP	801HP	48.2	< 6.9 / 100	-40 / +100	100		CuZn	-	

CVV (commercial vehicle valves)

Super easy to assemble

- **Pressure range:** Up to 7 bar / 102 psi
- **Properties:** Easy (dis)assembly, high pressure resistance

ADVANTAGES AT A GLANCE

- Secure sealing in the rim
- High pressure resistance
- Simplest hand assembly
- Easy removal – without special tools, without rim damage



9-530050

9-530060

9-530021
9-530020

9-530031
9-530030

9-530041
9-530040

Valve hole 11.3 + 0.4 mm

Art. no.	Description	ETRTO no.	Valve length (mm)	Pressure range (bar/psi)	Temperature range (°C)	Qty	Vehicle type	Material	Surface	Valve caps
9-530050	CVV31	V3.23.3	31	< 7 / 102	-40 / +130	20		CuZn	Ni	
9-530060	CVV31 with DS-P	V3.23.3	31	< 7 / 102	-40 / +130	20		CuZn	Ni	
9-530021	CVV40	V3.23.4	40	< 7 / 102	-40 / +130	20		CuZn	Ni	
9-530020	CVV40	V3.23.4	40	< 7 / 102	-40 / +130	100		CuZn	Ni	
9-530031	CVV47	V3.23.5	47	< 7 / 102	-40 / +130	20		CuZn	Ni	
9-530030	CVV47	V3.23.5	47	< 7 / 102	-40 / +130	100		CuZn	Ni	
9-530041	CVV60	V3.23.7	60	< 7 / 102	-40 / +130	20		CuZn	Ni	
9-530040	CVV60	V3.23.7	60	< 7 / 102	-40 / +130	100		CuZn	Ni	

CVV INSTRUCTION

ASSEMBLY

Quick and easy to assemble by hand

Preparation:

- Thoroughly clean the rim flange and valve hole area. Check the valve hole area of the rim for damage.
- Coat the valve with water/soapy water or similar suitable lubricants before installation.

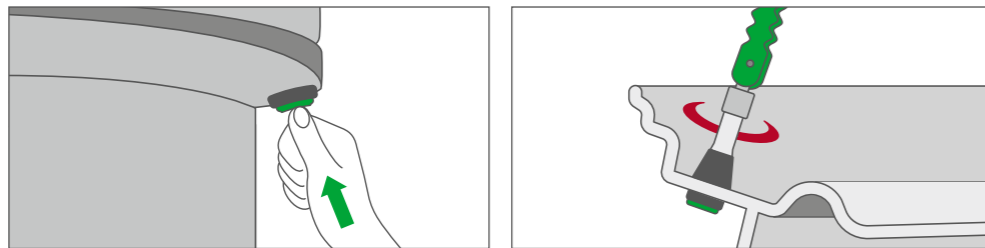

Press the valve in by hand without using too much force. Or mount gently with the ALLIGATOR standard valve mounting tool. The valve must be pulled in axially to the rim hole – do not tilt.

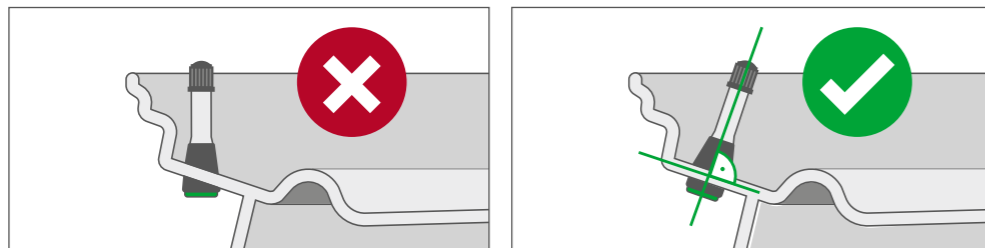

Make sure the valve is fitted correctly in the rim.

NOTE

In individual cases with an unfavorable rim geometry, you may need to turn the valve slightly for proper fitting.

Easy manual assembly without special tools.

DISASSEMBLY

Without rim damage, without special tools

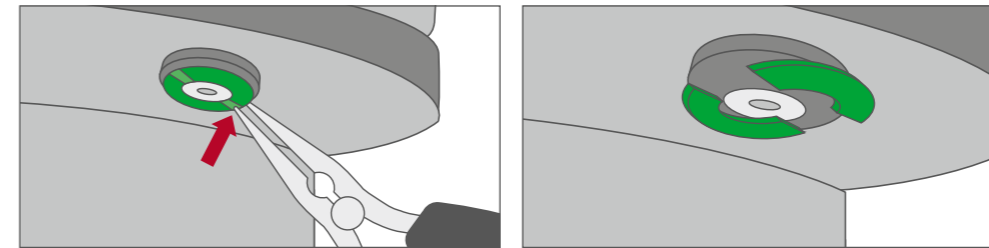

To disassemble, use tweezers or a screwdriver to crack the patented thrust washer at the marked predetermined breaking point and remove.

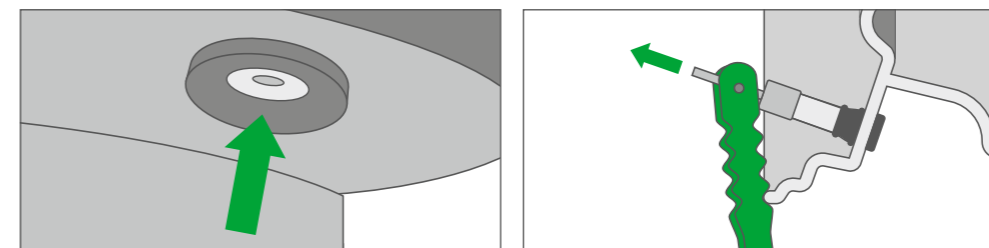

Now the valve can simply be pulled outwards through the valve hole with the ALLIGATOR standard valve mounting tool.

- Easy disassembly without special tools.
- No damage to the rim.

TRUCK VALVES



As an OE supplier, ALLIGATOR offers suitable solutions for haulage companies, bus companies, and transport associations with a wide range of different truck valves.

CONTENT

TPMS valves	44
Rim valves	46
Tube valves	60
Valve extensions	64

TPMS VALVES

For direct tire pressure monitoring systems

- **Application:** Truck with direct TPMS
- **Design:** Partially assembled; with screw system for connecting the sensor
- **Pressure range:** Up to 14 bar / 200 psi
- **Nut Installation torque:** 12 – 15 Nm. For TPMS 32MS 4 – 6 Nm.
- **Screw Installation torque:** 4 ± 0.5 Nm

Truck TPMS valves

Art. no.	Description	Valve length (mm)	Bending height A (mm)	Bending angle (α°)	Ø Valve hole (mm)	Qty	Vehicle type	Material	Surface	Valve caps
9-799724	TPMS 32MS	32	-	-	15,7	1		CuZn	-	
9-799820	TPMS 40MS	40	-	-	9,7	1		CuZn	Ni	
9-790524	TPMS 41MS	41	-	-	9,7	1		CuZn	-	
9-799998	TPMS 58MS	58	25.0	45	9,7	1		CuZn	-	
9-799926	TPMS 60MS	60	25.0	27	9,7	1		CuZn	Ni	
9-799840	TPMS 63MS	63	35.0	45	9,7	1		CuZn	-	
9-799810	TPMS 65MS	65	32.5	27	9,7	1		CuZn	Ni	
9-799830	TPMS 64MS	64	32.5	7	9,7	1		CuZn	Ni	
9-799924	TPMS 89MS	89	29.2	27	9,7	1		CuZn	Ni	

* Max. tightening torque 12 – 15 Nm. For TPMS 32MS 4 – 6 Nm.

All valves are supplied with a screw.

Spare part for truck TPMS valves (9-799xxx)

Art. no.	Description
9-031025	Screw M6, Torx TX20



9-799724



9-790524



9-799820

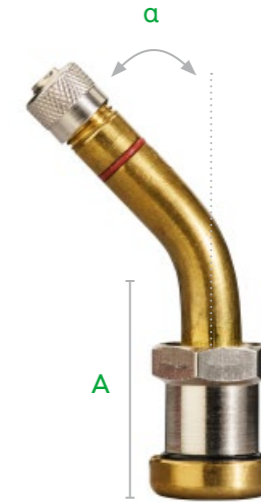

9-799998



9-799926



9-799840



9-799810



9-799830

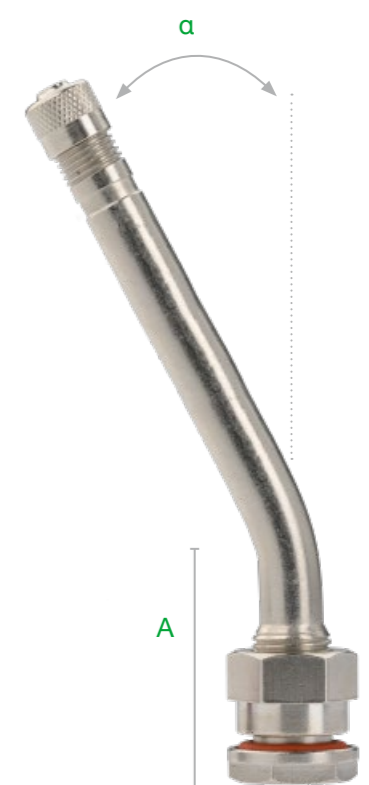

9-799924

RIM VALVES

For tubeless tires

- **Application:** For tubeless truck, bus, trailer tires
- **Versions:** Straight, single, double, and triple bent brass valves
- **Pressure range:** Up to 14 bar / 200 psi
- **Fit:** Valve hole must be according to ETRTO

Only use nickel-plated brass valves to avoid corrosion.

Highlights

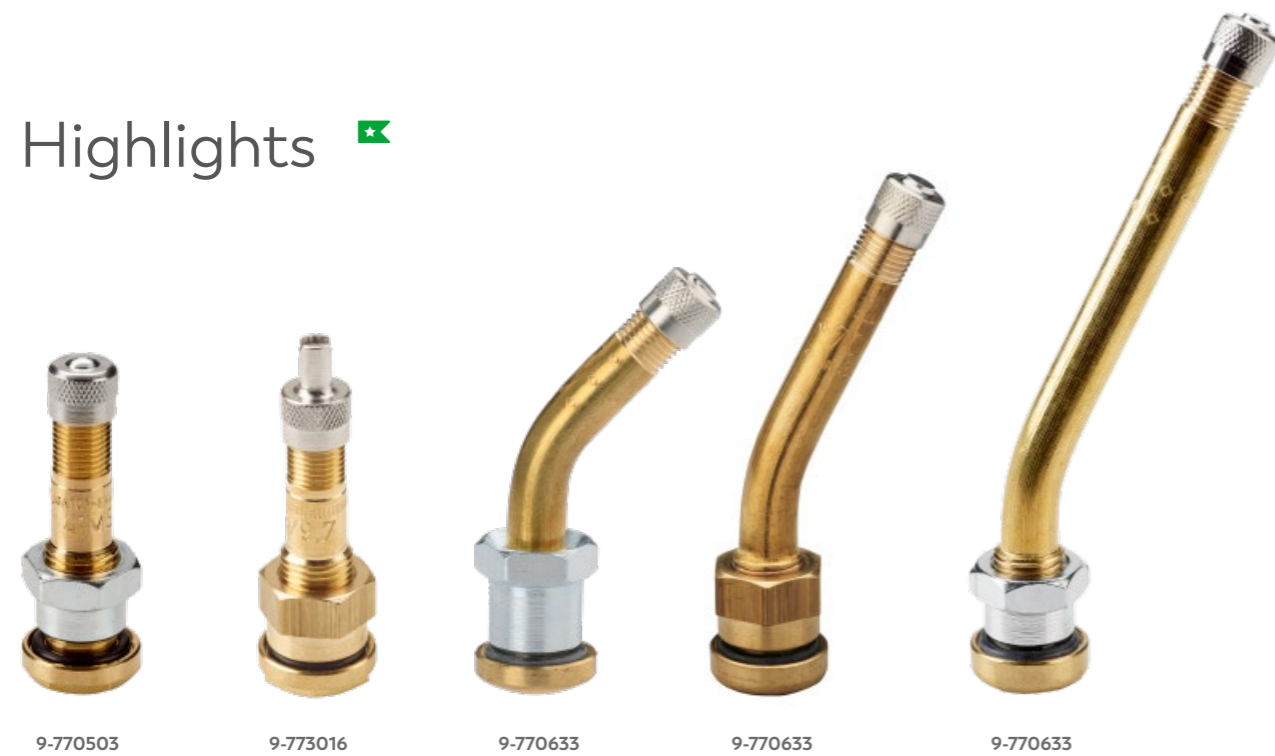

Valve hole 9.7 mm + 0.3 mm MS valves

- **Seal:** O-ring sealing or rubber grommet
- **Standard:** ETRTO V3.20.../V3.22.1 (European standard)
- **Rim thickness:** 3–6 mm
- **Rim:** Steel
- **Surface:** Brass / nickel-plated
- **Pressure range:** Up to 14 bar / 200 psi



9-770503

9-773016

41MS

Art. no.	ETRTO no.	Valve length (mm)	Installation torque (Nm)	Vehicle type	Material	Surface	Valve base	Valve caps
9-770503	V3.20.1eq	41	12–15		CuZn	-		
9-773016	V3.20.1	41	12–15		CuZn	-		

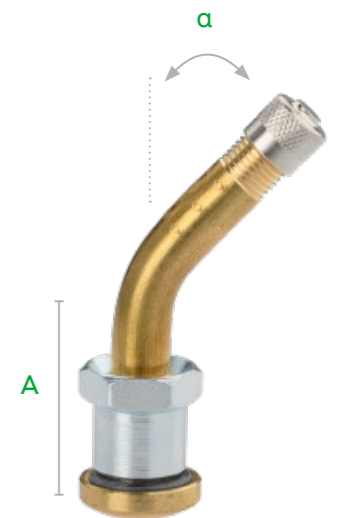

58MS

Art. no.	ETRTO no.	Valve length (mm)	Bending height A (mm)	Bending angle α (°)	Installation torque (Nm)	Vehicle type	Material	Surface	Valve caps
9-770630		58	30	45	12–15		CuZn	-	
9-770633	V3.22.1	58	30	45	12–15		CuZn	-	



70MS for Alcoa (extra-long thread)

Art. no.	Valve length (mm)	Bending height A (mm)	Bending angle α (°)	Installation torque (Nm)	Vehicle type	Material	Surface	Valve base	Valve caps
9-770625	70	40	27	9-14		CuZn	Ni		
9-770704	70	40	7	9-14		CuZn	Ni		



80MS - 119MS

Art. no.	ETRTO no.	Valve length (mm)	Bending height A (mm)	Bending angle α (°)	Installation torque (Nm)	Vehicle type	Material	Surface	Valve caps
9-770103	V3.20.7	80	30	27	12-15		CuZn	-	
9-770583	V3.20.4 eq	90	28	27	12-15		CuZn	-	
9-770223	V3.20.2	95	34	17.5	12-15		CuZn	-	
9-770273	V3.20.12	100	30	27	12-15		CuZn	-	
9-770283		100	57	12	12-15		CuZn	-	
9-770233	V3.20.6	115	30	27	12-15		CuZn	-	
9-770333	V3.20.8	119	37	12	12-15		CuZn	-	
9-770303		119	37	27	12-15		CuZn	-	
9-774213		119	30	27	12-15		CuZn	-	



70MS

Art. no.	Valve length (mm)	Bending height A (mm)	Bending angle α (°)	Installation torque (Nm)	Vehicle type	Material	Surface	Valve base	Valve caps
9-773553	70	30	27	12-15		CuZn	-	-	
9-773513	70	30	27	9-14		CuZn	Ni		
9-770646	70	30	27	9-14		CuZn	Ni	-	
9-770643	70	30	60	9-14		CuZn	Ni	-	

Valve hole 9.7 mm + 0.4 mm TR54x + TR55x

- **Seal:** O-ring sealing (TR54x) / rubber grommet (TR55x)
- **Standard:** TR54x / TR55x (US standard)
- **Rim thickness:** 5.5–8.4 mm
- **Rim:** Alu/Alcoa
- **Surface:** Nickel-plated
- **Pressure range:** Up to 14 bar / 200 psi
- **Installation torque:** 9–14 Nm



TR54x - straight

Art. no.	TR no.	Valve length (mm)	Vehicle type	Material	Surface	Valve caps
9-770669	542	37		CuZn	Ni	
9-770699	543	64		CuZn	Ni	
9-097755	544	78		CuZn	Ni	
9-097738	545	94		CuZn	Ni	
9-097745	546	113		CuZn	Ni	

TR543C - 45°

Art. no.	TR no.	Valve length (mm)	Bending height A (mm)	Bending angle α (°)	Vehicle type	Material	Surface	Valve caps
9-770695	543C	64	29	45		CuZn	Ni	

TR54xD - 60°

Art. no.	TR no.	Valve length (mm)	Bending height A (mm)	Bending angle α (°)	Vehicle type	Material	Surface	Valve caps
9-770696	543D	64	29	60		CuZn	Ni	
9-770686	544D	78	30	60		CuZn	Ni	
9-779677	545D	94	30	60		CuZn	Ni	
9-097747	546D	113	30	60		CuZn	Ni	
9-097752	547D	124	30	60		CuZn	Ni	

TR54xE - 75°

Art. no.	TR no.	Valve length (mm)	Bending height A (mm)	Bending angle α (°)	Vehicle type	Material	Surface	Valve caps
9-770697	543E	64	30	75		CuZn	Ni	
9-097739	545E	94	30	75		CuZn	Ni	
9-097748	546E	113	30	75		CuZn	Ni	

TR55x - straight



Art. no.	TR no.	Valve length (mm)	Vehicle type	Material	Surface	Valve caps
9-771510	552	37		CuZn	Ni	
9-771515	553	64		CuZn	Ni	

TR553C - 45°



Art. no.	TR no.	Valve length (mm)	Bending height A (mm)	Bending angle α (°)	Vehicle type	Material	Surface	Valve caps
9-771520	553C	64	29	45		CuZn	Ni	

TR55xD - 60°



Art. no.	TR no.	Valve length (mm)	Bending height A (mm)	Bending angle α (°)	Vehicle type	Material	Surface	Valve caps
9-771544	554D	78	30	60		CuZn	Ni	
9-771550	555D	94	30	60		CuZn	Ni	

TR55xE - 45°



Art. no.	TR no.	Valve length (mm)	Bending height A (mm)	Bending angle α (°)	Vehicle type	Material	Surface	Valve caps
9-771530	553E	64	30	75		CuZn	Ni	
9-771555	555E	94	30	75		CuZn	Ni	

Valve hole 15.7 + 0.4 mm TR5xx

- Seal: Rubber grommet
- Standard: ETRTO V3.21 (Europe) / TR5xx (US standard)
- Rim thickness: Max. 9 mm
- Rim: Steel
- Surface: Brass
- Pressure range: Up to 14 bar / 200 psi
- Installation torque: 4-6 Nm

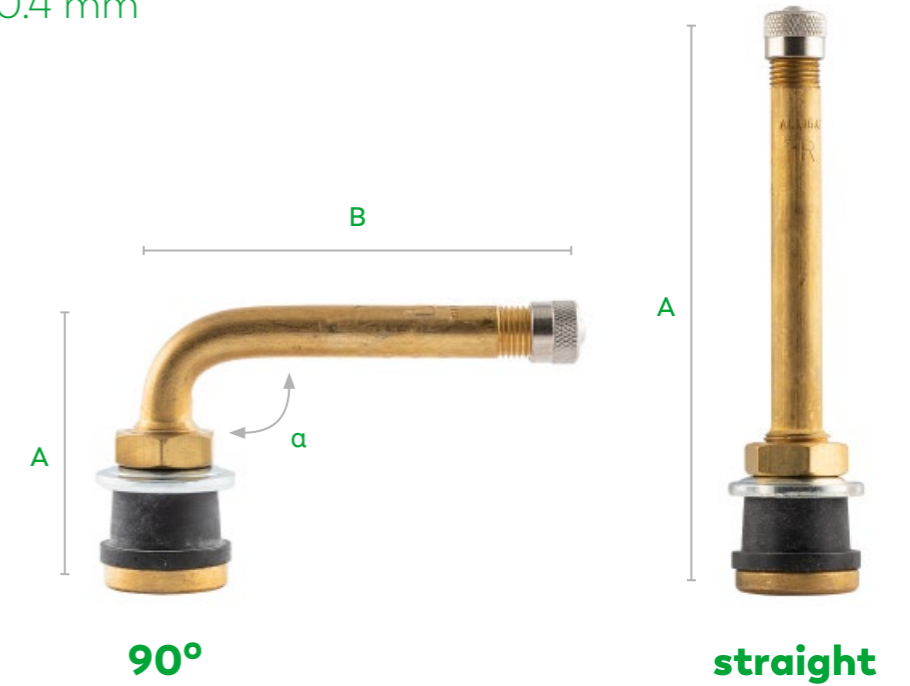

TR57xC - 90°

Art. no.	TR no.	ETRTO no.	Valve length (mm)	Bending height A (mm)	Bending angle α (°)	Vehicle type	Material	Valve caps
9-752803	571C	V3.21.10	88	37	55		CuZn	
9-753303	572C	V3.21.11	99	37	66		CuZn	
9-753803	573C	V3.21.12	114	37	81		CuZn	

TR50x/TR57x - straight

Art. no.	TR no.	ETRTO no.	Valve length (mm)	Vehicle type	Material	Valve caps
9-750603	575	V3.21.1	33		CuZn	
9-750701	575	V3.21.1	32		CuZn	
9-751103	501	V3.21.2	42		CuZn	
9-751101	501	V3.21.2	42		CuZn	
9-753603	573	V3.21.7	114		CuZn	

Valve hole 15.7

MSF valves

- **Seal:** O-ring sealing
- **Standard:** ETRTO V3.11 - V3.19 (European standard)
- **Rim thickness** 3.5–6 mm / 7.5–9 mm
- **Rim:** Steel
- **Surface:** Brass
- **Pressure range:** Up to 14 bar / 200 psi
- **Installation torque:** 25–31 Nm



A

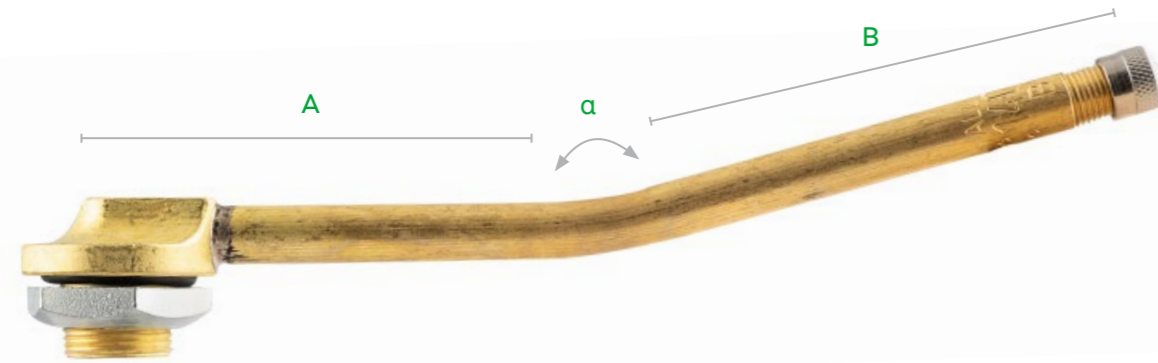

B4

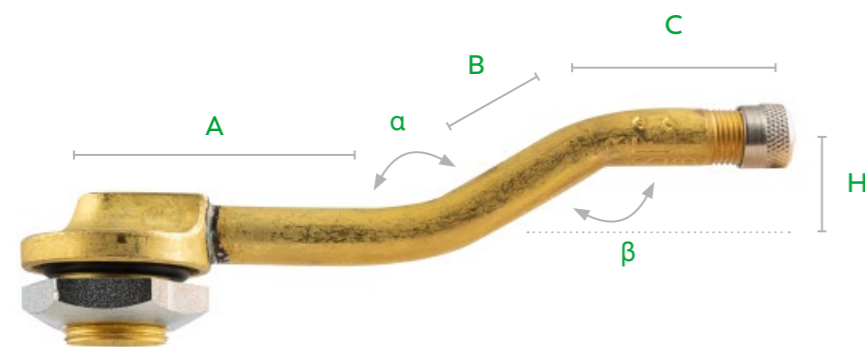

C1

Form A



Art. no.	Description	ETRTO no.	Valve length (mm)	A (mm)	Vehicle type	Material	Valve caps
9-771153	40MSF	V3.12.1	40	40.0		CuZn	
9-771154	40MSF	V3.12.1	40	40.0		CuZn	
9-771163	40MSF for rim thickness 7.5–9.0 mm	V3.12.1	40	40.0		CuZn	
9-771170	65MSF	V3.12.1	65	65.0		CuZn	
9-771183	95MSF	V3.12.2	95	95.0		CuZn	

Form B4



Art. no.	Description	Valve length (mm)	A (mm)	B (mm)	Bending angle α (°)	Vehicle type	Material	Valve caps
9-771783	140MSF	140	67	73	165		CuZn	

Form C1



Art. no.	Description	ETRTO no.	Valve length (mm)	A (mm)	B (mm)	C (mm)	H (mm)	Bending angle α (°)	Bending angle β (°)	Vehicle type	Material	Valve caps
9-771243	75MSF	V3.14.1	75	25.0	25.5	24.5	14	147	147		CuZn	
9-771253	95MSF	V3.14.2	95	45.0	25.5	24.5	14	147	147		CuZn	
9-771283	110MSF	V3.16.1	110	25.0	42.0	44.5	10	167	167		CuZn	

Valve hole plug



Art. no.	Installation torque (Nm)	Vehicle type	Material
9-328501	4–6 Nm		CuZn

Valves MSF 20.5 + 0.5 mm

MSF valves

- **Seal:** O-ring sealing
- **Standard:** ETRTO V3.11 - V3.19 (European standard)
- **Rim thickness:** 3.5–6 mm
- **Rim:** Steel

- **Surface:** Brass
- **Pressure range:** Up to 14 bar / 200 psi
- **Installation torque:** 25–31 Nm

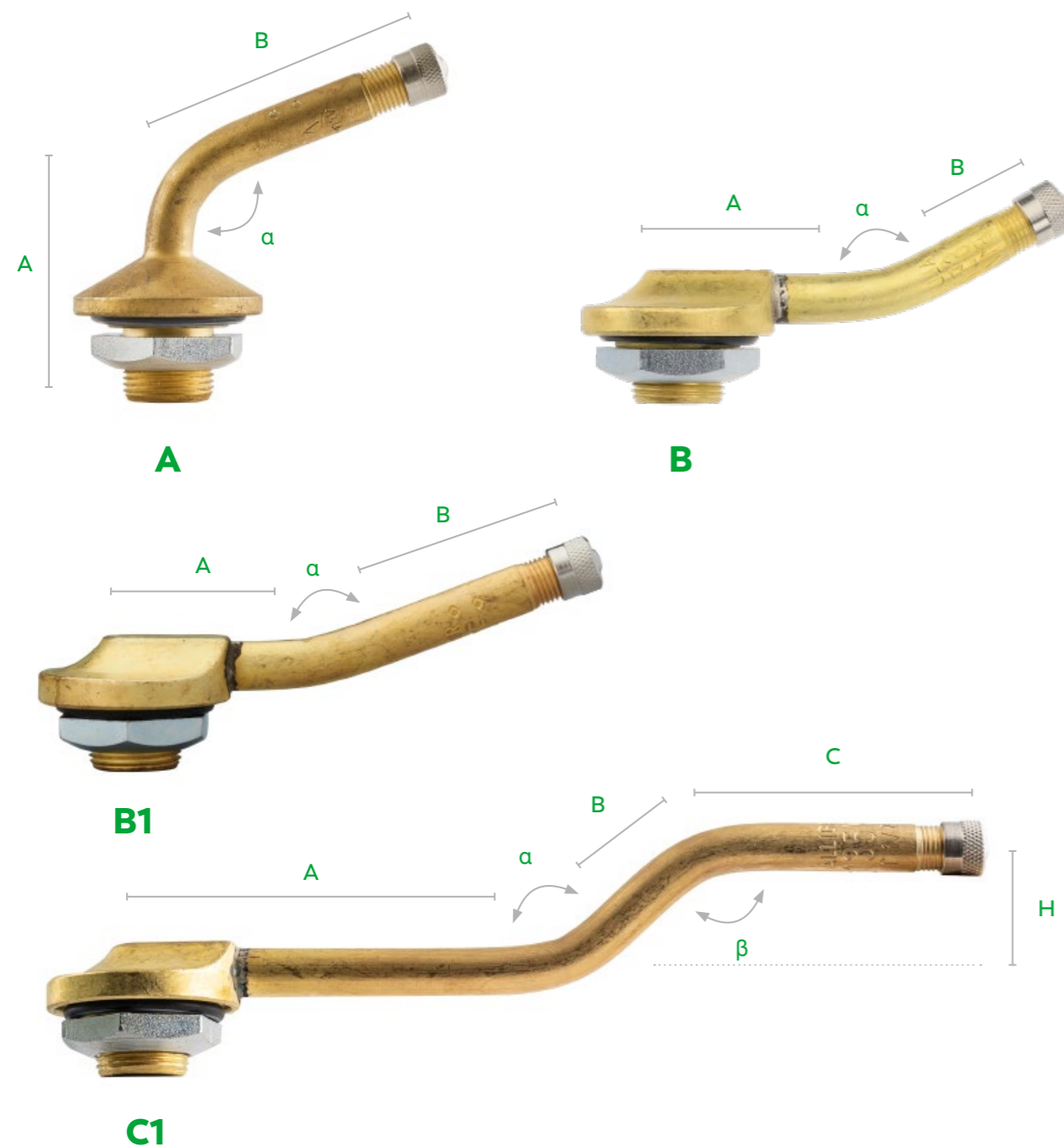

Form A

Art. no.	Description	ETRTO no.	Valve length (mm)	A (mm)	B (mm)	C (mm)	Bending angle α (°)	Rim thickness (mm)	Vehicle type	Material	Valve caps
9-770723	44.5MSF	V3.15.1	44.5	36.5	44.5	14	110	4.5–11		CuZn	
9-770733	44.5MSF	V3.15.2	44.5	26.5	44.5	11	95	3–6.5		CuZn	

Form B1

Art. no.	Description	ETRTO no.	Valve length (mm)	A (mm)	B (mm)	Bending angle α (°)	Rim thickness (mm)	Vehicle type	Material	Valve caps
9-771033	65MSF	V3.16.1	65	36	29	150	3.5–6		CuZn	
9-771043	75MSF		75	28	47	160	3.5–6		CuZn	
9-771083	140MSF		140	67	73	165	3.5–6		CuZn	
9-771093	160MSF		160	83	77	165	3.5–6		CuZn	

Form C1

Art. no.	Description	ETRTO no.	Valve length (mm)	A (mm)	B (mm)	C (mm)	H (mm)	Bending angle α (°)	Bending angle β (°)	Rim thickness (mm)	Vehicle type	Material	Valve caps
9-770973	135MSF	V3.18.5	135	68	29	37.5	19.5	138	138	3.5–6		CuZn	
9-770993	145MSF		145	27	35	82.5	17.5	150	150	3.5–6		CuZn	



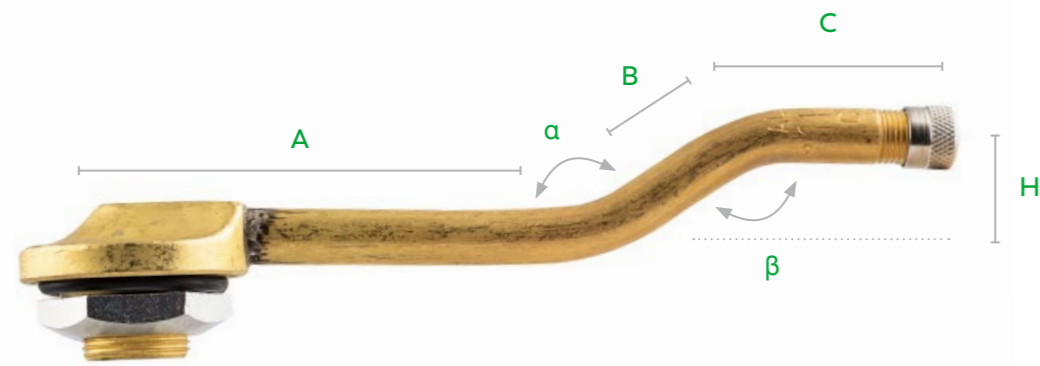

C2

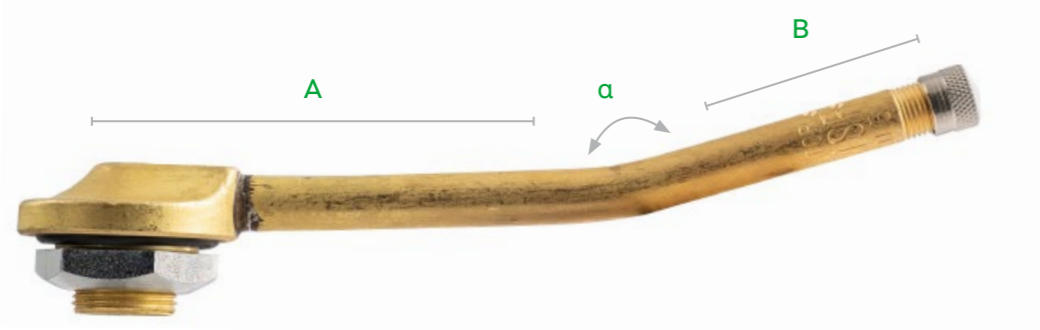

C4



D1

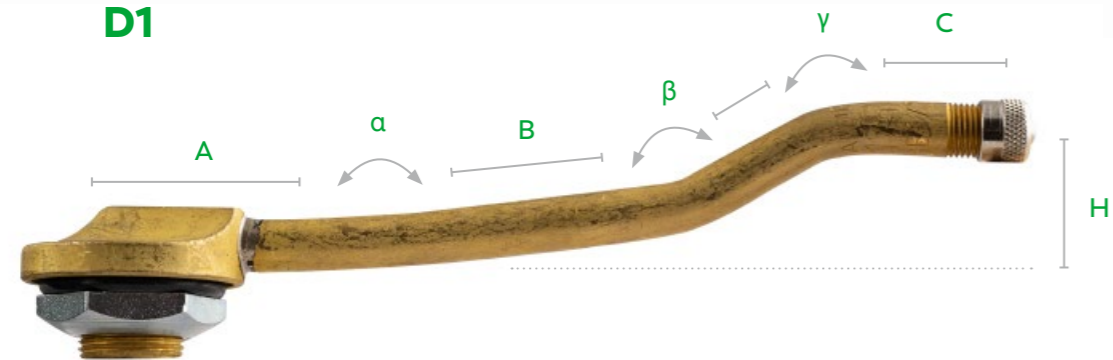

E1



Form C2

Art. no.	Description	ETRTO no.	Valve length (mm)	A (mm)	B (mm)	C (mm)	H (mm)	Bending angle α (°)	Bending angle β (°)	Rim thickness (mm)	Vehicle type	Material	Valve caps
9-770933	115MSF	V3.18.1	115	64	26	24.5	14	146	146	3.5-6		CuZn	
9-770963	130MSF	V3.18.2	130	81	26	24.5	14.5	146	146	3.5-6		CuZn	



Form C4

Art. no.	Description	Valve length (mm)	A (mm)	B (mm)	C (mm)	Bending angle α (°)	Rim thickness (mm)	Vehicle type	Material	Valve caps
9-770943	120MSF	120	25	45	50	165	3.5-6		CuZn	



Form D1

Art. no.	Description	ETRTO no.	Valve length (mm)	Form	A (mm)	B (mm)	Bending angle α (°)	Rim thickness (mm)	Vehicle type	Material	Valve caps
9-770863	130MSF	V3.17.1	130	D1	98.5	31.5	188	3.5-6		CuZn	
9-770883	147MSF	V3.17.2	147	D1	116	31.5	188	3.5-6		CuZn	



Form E1

Art. no.	Description	ETRTO no.	Valve length (mm)	A (mm)	B (mm)	C (mm)	D (mm)	H (mm)	Bending angle α (°)	Bending angle β (°)	Bending angle γ (°)	Rim thickness (mm)	Vehicle type	Material	Valve caps
9-770773	140MSF	V3.19.1	140	33.5	58	24	24.5	21.5	173	154	147	3.5-6		CuZn	

TUBE VALVES

For tires with tube (tube type)

- **Application:** Truck, bus, trailer tires with tube
- **Versions:** Single, double, and triple bent brass valves
- **Pressure range:** Up to 10.5 bar / 150 psi
- **Fit:** Valve hole must comply with ETRTO

For 8V1 thread

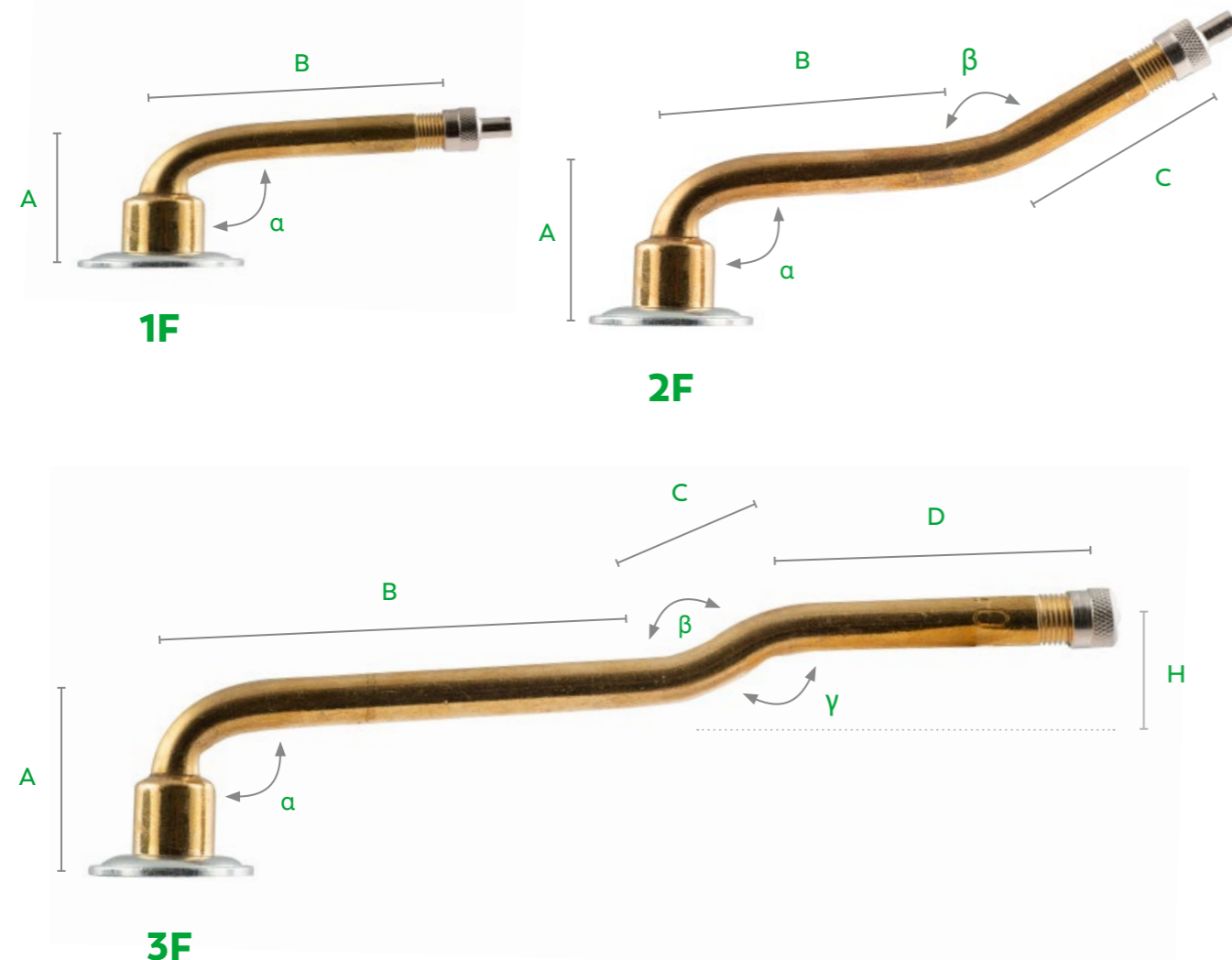

Form F1

8V1 thread



Art. no.	TR no.	ETRTO no.	A (mm)	B (mm)	Bending angle α (°)	Vehicle type	Material	Valve caps
9-730173		V3.02.5	23.5	47.5	90		CuZn	
9-730163		V3.02.2	25.5	43.0	120		CuZn	
9-730623		0	25.5	56.5	95		CuZn	
9-730603		V3.02.19	23.5	60.0	94		CuZn	
9-730613		V3.02.3	36.0	44.5	95		CuZn	
9-731103			23.0	70.0	94		CuZn	
9-731601	75E		23.0	75.0	94		CuZn	
9-731603	75E		23.0	75.0	94		CuZn	
9-731613	75D	V3.02.7	25.5	71.5	100		CuZn	
9-732301			23.5	79.5	90		CuZn	
9-732303	76EQ		23.5	84.5	94		CuZn	
9-733101	177EQ		23.0	95.0	94		CuZn	
9-733103	177EQ		23.0	95.0	94		CuZn	
9-734101	77E		23.0	105.0	94		CuZn	
9-734103			23.0	105.0	94		CuZn	
9-735101		V3.02.10	23.5	115.0	94		CuZn	
9-735103	175	V3.02.10	23.5	115.0	94		CuZn	
9-735601	78E		23.0	127.0	94		CuZn	
9-735603	78EQ		23.0	127.0	94		CuZn	
9-736101	178	V3.02.12	23.5	132.0	94		CuZn	
9-736103	178	V3.02.12	23.5	132.0	94		CuZn	
9-736601	179	V3.02.14	23.5	138.5	94		CuZn	

Spare part for tube valve 8V1 (9-73xxxx)



Art.Nr.	Description	ETRTO no.	Material
9-030753	Sealing washer	V9.05.1	Rubber

Form 2F

8V1 thread



Art. no.	TR no.	ETRTO no.	A (mm)	B (mm)	C (mm)	Bending angle α (°)	Bending angle β (°)	Vehicle type	Material	Valve caps
9-731701	7		23.0	28.0	47.0	94	164		CuZn	
9-731723			23.0	28.0	47.0	94	164		CuZn	
9-732213		V3.04.8	23.5	38.5	43.0	90	167		CuZn	
9-732253		V3.04.15	23.5	42.0	38.5	90	120		CuZn	
9-733203		V3.04.23	23.0	48.0	47.0	94	164		CuZn	
9-733723		V3.04.10	23.5	47.0	53.0	90	154		CuZn	
9-734203		V3.04.24	23.0	58.0	47.0	94	164		CuZn	
9-735203		V3.04.18	23.0	68.0	47.0	94	164		CuZn	
9-735703	78EQ	V3.04.25	23.0	80.0	47.0	94	164		CuZn	
9-736703	179EQ	V3.04.21	23.0	83.0	57.0	94	154		CuZn	

Form 3F

8V1 thread



Art. no.	TR no.	ETRTO no.	A (mm)	B (mm)	C (mm)	D (mm)	H (mm)	Bending angle α (°)	Bending angle β (°)	Bending angle γ (°)	Vehicle type	Material	Valve caps
9-733303		V3.06.13	23.0	40.0	13.0	40.0	7.0	94	153	153		CuZn	
9-734303		V3.06.14	23.0	50.0	13.0	40.0	7.0	94	153	153		CuZn	
9-735303		V3.06.15	23.0	60.0	13.0	40.0	7.0	94	153	153		CuZn	
9-735801	78E	V3.06.16	23.0	62.0	13.0	50.0	7.0	94	153	153		CuZn	
9-735803	78E	V3.06.16	23.0	62.0	13.0	50.0	7.0	94	153	153		CuZn	
9-736343		V3.06.5	23.5	62.5	19.5	49.0	17.0	90	139	139		CuZn	
9-736353		V3.06.8	27.5	61.5	14.5	50.5	7.5	94	153	153		CuZn	
9-736803	179	V3.06.17	23.0	75.0	13.0	50.0	7.0	94	153	153		CuZn	

For 12V1 thread

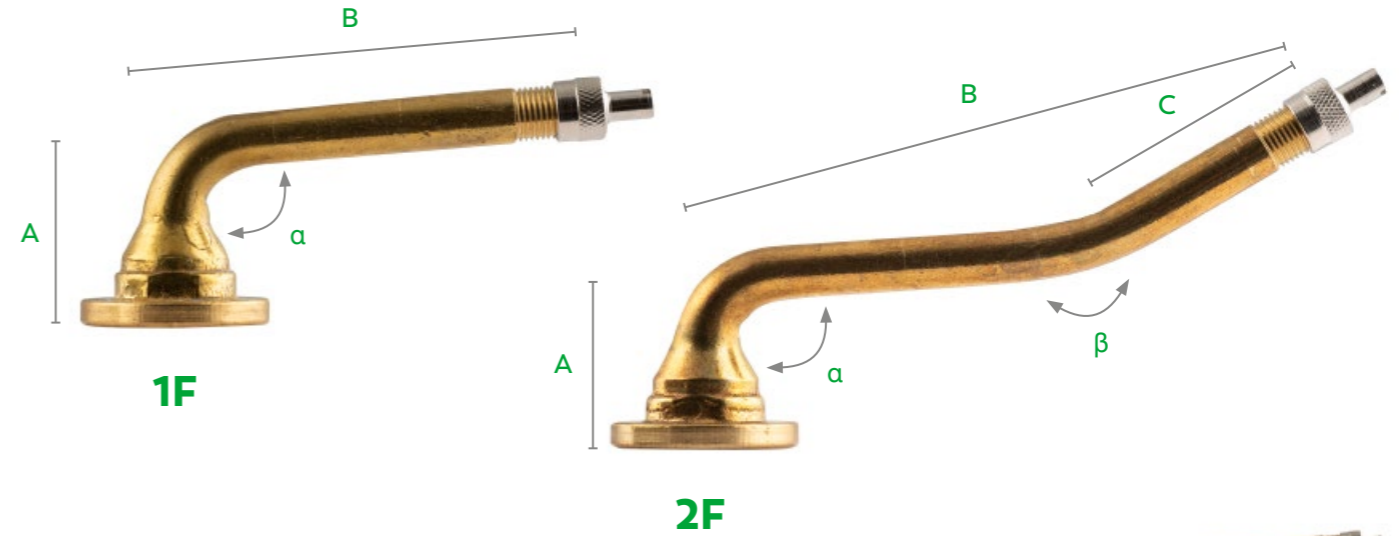

Form 1F

12V1 thread



Art. no.	TR no.	A (mm)	B (mm)	Bending angle α (°)	Vehicle type	Material	Valve caps
9-710101	1227A	24.0	50.0	86		CuZn	
9-710601	1274A	24.0	60.0	86		CuZn	
9-711601	1075A	24.0	75.0	86		CuZn	
9-712601	1177A	24.0	95.0	86		CuZn	
9-701601	75	32.0	75.0	86		CuZn	
9-703101	177	32.0	95.0	86		CuZn	

Form 2F

for 12V1 thread



Art. no.	TR no.	A (mm)	B (mm)	C (mm)	Bending angle α (°)	Bending angle β (°)	Vehicle type	Material	Valve caps
9-712701	1177A	24.0	90.0	38.0	86	26		CuZn	

Spare part for tube valve 12V1 (9-71xxxx)

Art.Nr.	Description	ETRTO no.	Material
9-030754	Sealing washer	V9.05.1	Rubber

VALVE EXTENSIONS

Tool for hard to reach valves

- **Application:** Twin truck tires
- **Design:** Rigid and flexible
- **Fit:** Length depends on the wheel conditions (rim-center distance)
- **Suitable for:** All standard valve sizes (8V1); do not use with rubber valves

- Select suitable length.
- Valve extensions remain permanently screwed onto the valve.
- Valve extensions not suitable for snap-in valves.
- Leave the valve core in the valve.

Valve extension variants

Overview



	Highly flexible	Flexible	Rigid
Material	With fabric	With steel sheath	Plastic or brass
Flexibility	100%	95%	0%
Extension insert	sealing	sealing	not sealing
Pressure range	up to 20 bar / 290 psi	up to 20 bar / 290 psi	unpressurized
Compressive strength/burst pressure	70 bar / 1015 psi	120 bar / 1740 psi	150 bar / 2175 psi
Professional assembly	with fixed clamp	with fixed clamp	can be used without holder
Breakage resistance	very high	very high	low

Support collar

The support for rigid valve extensions

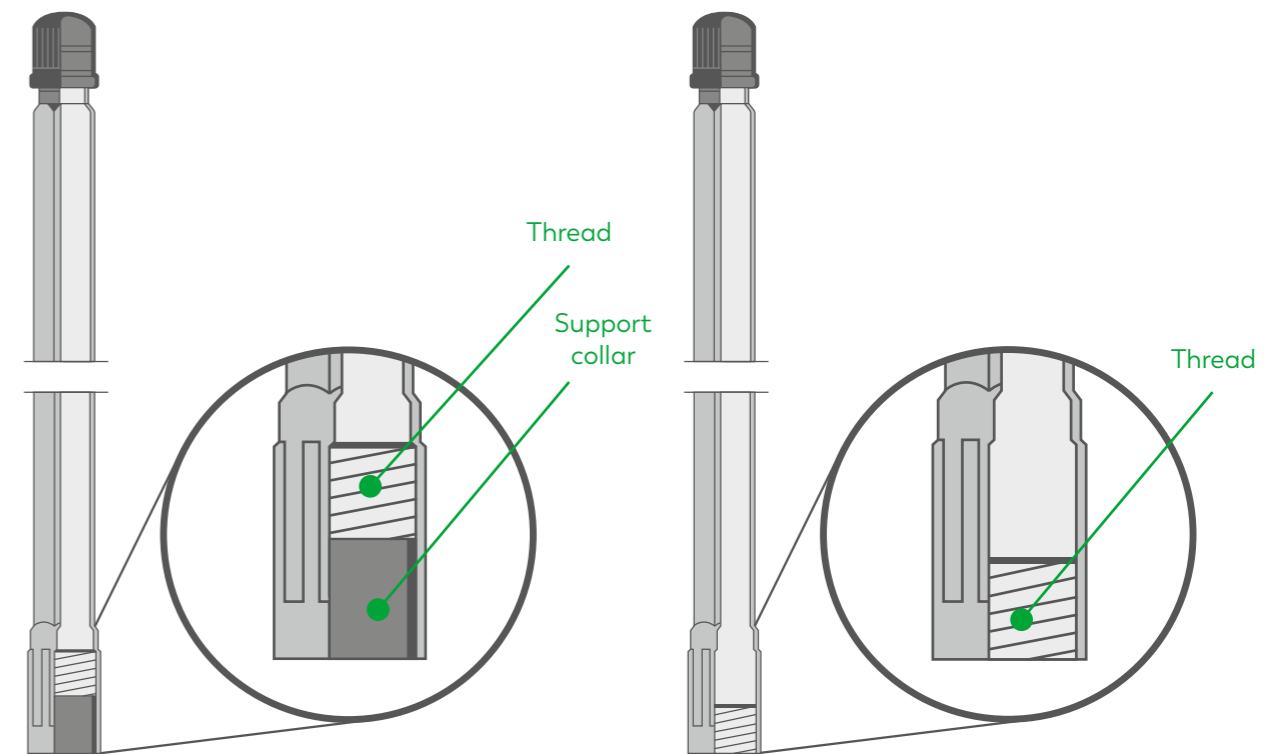

with support collar

without support collar

- More stability
- Higher break resistance
- Easier assembly due to guiding of the support collar

Plastic

Rigid

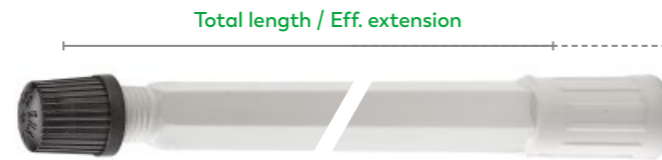

With support collar

Art. no.	ETRTO no.	Total length (mm)	Effective extension (mm)	Vehicle type	Material	Valve caps
9-381504	V9.16.1	71	53		Plastic	
9-381805	V9.16.2	95	78		Plastic	
9-382604	V9.16.3	115	98		Plastic	
9-382705	V9.16.4	125	108		Plastic	
9-382804	V9.16.5	150	132		Plastic	
9-382904	V9.16.6	170	153		Plastic	
9-383005	V9.16.7	180	163		Plastic	

Without support collar

Art. no.	ETRTO no.	Total length (mm)	Effective extension (mm)	Vehicle type	Material	Valve caps
9-382405	V9.16.2	85	78		Plastic	
9-382435	V9.16.3	105	98		Plastic	
9-382465	V9.16.4	115	108		Plastic	

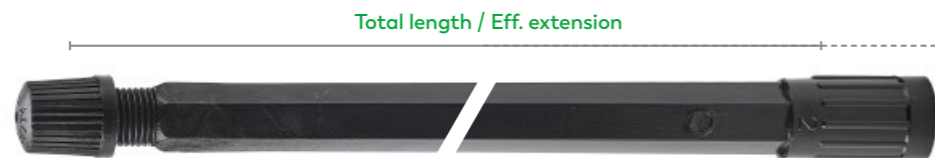

With support collar

Art. no.	ETRTO no.	Total length (mm)	Effective extension (mm)	Vehicle type	Material	Valve caps
9-382607	V9.16.3	115	98		Plastic	
9-382807	V9.16.5	150	133		Plastic	
9-382907	V9.16.6	170	153		Plastic	

Brass

Rigid



Bended

Art. no.	Total length (mm)	Effective extension (mm)	Bending angle (°)	Bending height (mm)	Vehicle type	Material	Valve caps
9-330935	48	29	45	21.0		CuZn	
9-330903	55	35	90	20.5		CuZn	
9-330905	55	35	90	20.5		CuZn	

Without support collar



Art. no.	Total length (mm)	Effective extension (mm)	Vehicle type	Material	Valve caps
9-331103	30	24		CuZn	
9-331203	40	34		CuZn	
9-331403	60	54		CuZn	
9-331703	84	78		CuZn	
9-332003	100	94		CuZn	



With support collar

Art. no.	Total length (mm)	Effective extension (mm)	Vehicle type	Material	Valve caps
9-331303	41.5	27		CuZn	
9-331353	58	41		CuZn	
9-332603	115	100		CuZn	
9-332703	124.5	110		CuZn	
9-332883	142	127		CuZn	
9-332903	178	153		CuZn	

Rubber

Highly flexible

Rubber



Art. no.	Total length (mm)	Effective extension (mm)	Pressure range (bar/psi)	Vehicle type	Material	Valve caps
9-370008	75	69	20 / 290		Rubber	
9-370018	85	79	20 / 290		Rubber	
9-370028	105	99	20 / 290		Rubber	
9-370038	115	109	20 / 290		Rubber	
9-370168	125	119	20 / 290		Rubber	
9-370188	140	134	20 / 290		Rubber	
9-370198	160	154	20 / 290		Rubber	
9-370228	180	174	20 / 290		Rubber	*
9-370248	210	204	20 / 290		Rubber	*
9-370288	270	264	20 / 290		Rubber	
9-370328	335	329	20 / 290		Rubber	
9-370388	370	364	20 / 290		Rubber	
9-370408	430	424	20 / 290		Rubber	
9-370428	475	469	20 / 290		Rubber	
9-370438	695	689	20 / 290		Rubber	
9-370440	1500	1.494	20 / 290		Rubber	

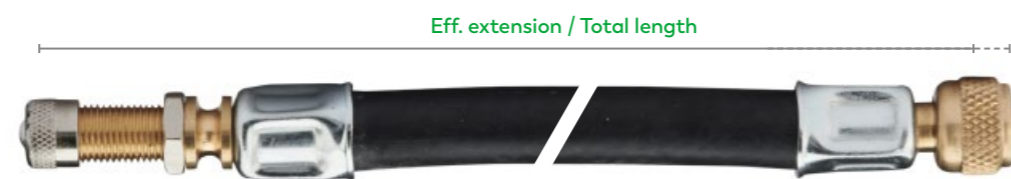

Rubber with hex nut

Art. no.	Total length (mm)	Effective extension (mm)	Vehicle type	Material	Valve caps
9-370013	85	79		Rubber	
9-370023	105	99		Rubber	
9-370163	125	119		Rubber	
9-370183	140	134		Rubber	
9-370223	180	174		Rubber	
9-370253	210	204		Rubber	



90° Angle

Art. no.	Effective extension (mm)	Hose length (mm)	Bending angle (°)	Bending height (mm)	Pressure range (bar/psi)	Vehicle type	Material	Valve caps
9-378578	135	103	90	14	20 / 290		Rubber	
9-378638	205	173	90	14	20 / 290		Rubber	
9-378688	275	243	90	14	20 / 290		Rubber	
9-378798	355	323	90	14	20 / 290		Rubber	
9-378868	455	423	90	14	20 / 290		Rubber	



2x 90° Angle

Art. no.	Effective extension (mm)	Hose length (mm)	Bending angle (°)	Vehicle type	Material	Valve caps
9-336507	360	340	2 x 90		Rubber	

Spare part

Art. no.	Description	TR no.	Wrench size	Vehicle type	Material	Surface
9-320000	Hexagon nut	LN3EQ	10		CuZn	Ni

Rubber with steel braid

Flexible



Rubber with steel braid

Art. no.	Total length (mm)	Effective extension (mm)	Pressure range (bar/psi)	Vehicle type	Material	Valve caps
9-333008	125	119	20 / 290		Rubber / Fe	
9-333068	130	124	20 / 290		Rubber / Fe	
9-333108	150	144	20 / 290		Rubber / Fe	
9-371198	160	154	20 / 290		Rubber / Fe	
9-333208	175	169	20 / 290		Rubber / Fe	
9-333268	180	174	20 / 290		Rubber / Fe	
9-333308	200	194	20 / 290		Rubber / Fe	
9-333328	210	204	20 / 290		Rubber / Fe	
9-333408	250	244	20 / 290		Rubber / Fe	
9-333508	300	294	20 / 290		Rubber / Fe	
9-333708	400	394	20 / 290		Rubber / Fe	
9-333808	450	444	20 / 290		Rubber / Fe	
9-333908	500	494	20 / 290		Rubber / Fe	

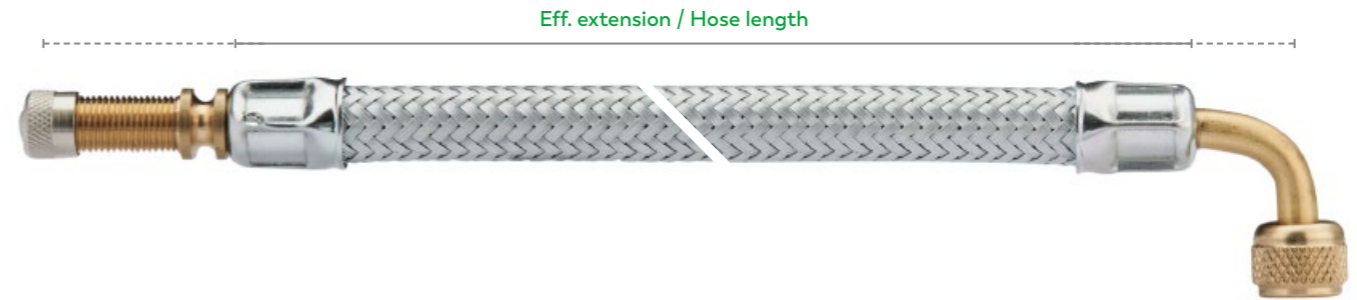

90° Angle

Art. no.	Effective extension (mm)	Hose length (mm)	Bending angle (°)	Bending height (mm)	Pressure range (bar/psi)	Vehicle type	Material	Valve caps
9-336108	150	113	90	14	20 / 290		Rubber / Fe	
9-336408	250	213	90	14	20 / 290		Rubber / Fe	
9-336508	300	263	90	14	20 / 290		Rubber / Fe	
9-336509	900	863	90	14	20 / 290		Rubber / Fe	

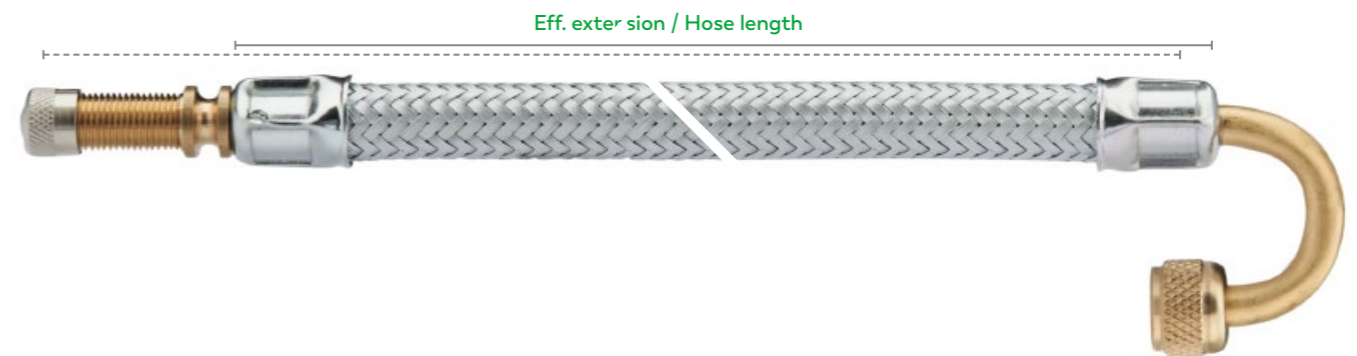

180° Angle

Art. no.	Effective extension (mm)	Hose length (mm)	Bending angle (°)	Pressure range (bar/psi)	Vehicle type	Material	Valve caps
9-338258	270	245	180°	20 / 290		Rubber / Fe	

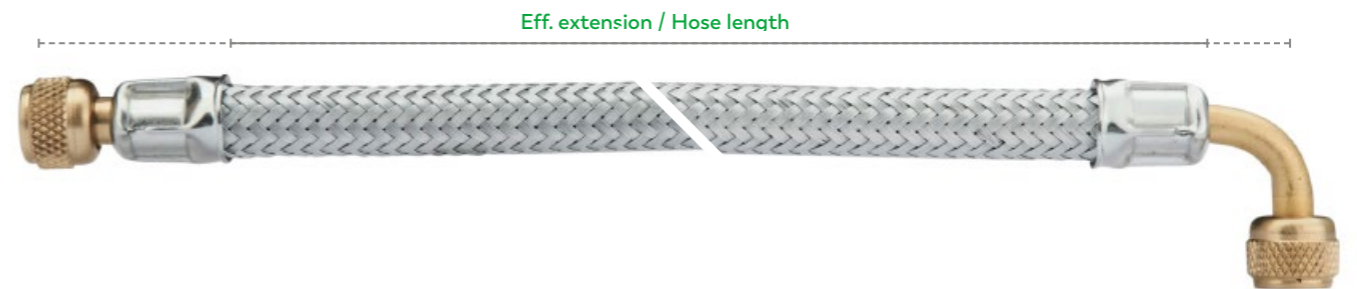

90° Angle + 2x valve connectors

Art. no.	Effective extension (mm)	Hose length (mm)	Bending angle (°)	Bending height (mm)	Pressure range (bar/psi)	Material
9-331468	274.5	250	90	15	20 / 290	Rubber / Fe

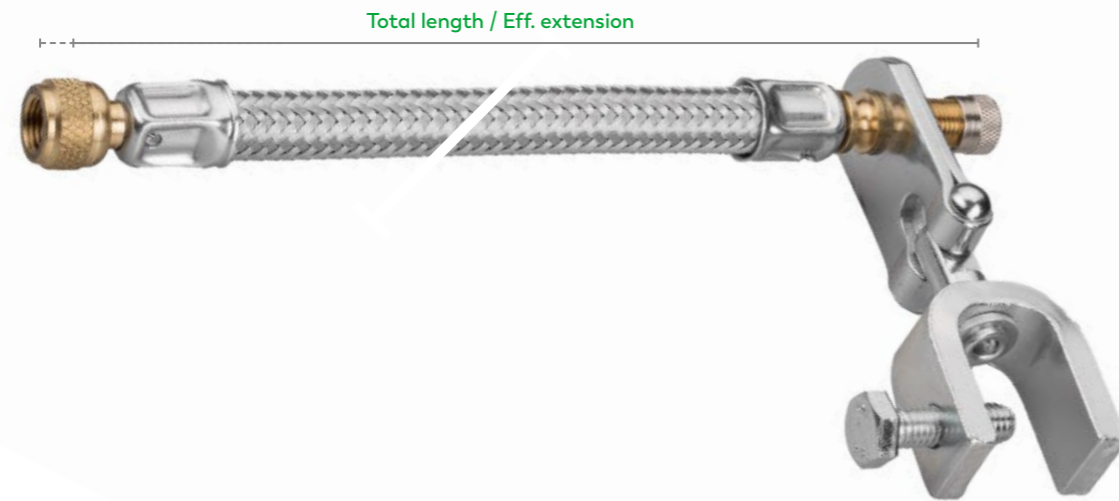

Rubber with steel braid and joint holder

Art. no.	Total length (mm)	Effective extension (mm)	Pressure range (bar/psi)	Vehicle type	Material	Valve caps
9-333006	125	119	20 / 290		Rubber / Fe	
9-333106	150	144	20 / 290		Rubber / Fe	
9-333206	175	169	20 / 290		Rubber / Fe	
9-333306	200	194	20 / 290		Rubber / Fe	
9-333406	250	244	20 / 290		Rubber / Fe	
9-333506	300	294	20 / 290		Rubber / Fe	



Spare part for (highly) flexible valve extensions

Art. no.	Description	TR no.	Length (mm)	Wrench size	Vehicle type	Material	Surface
9-377700	Holder		16			Fe	Zn
9-377702	Holder for aluminum wheels		26			Fe	Zn
9-377710	Holder double		-			Fe	Zn
9-337501	Joint holder		16			Fe	Zn
9-320000	Hexagon nut	LN3EQ	-	10		CuZn	Ni

ALLIGATOR VALVES

ALWAYS THE RIGHT CHOICE!





AGRICULTURAL VALVES

ALLIGATOR's product range includes air/water valves, especially designed for the agricultural sector. They are used to fill tractor tires with water and air, safely and reliably.

CONTENT

Air/water valves	80
Accessories for agricultural valves	82
Water filling and emptying devices	83

AIR/WATER VALVES

For filling tires with water to increase traction

- **Application:** Tractor
- **Properties:** Wide valve passage allowing large tires to be filled quickly
- **Valve hole:** 15.7 + 0.4 mm
- **Installation torque:** 5–8 Nm



Tube base valve

Art. no.	Length (mm)	Vehicle type	Material	Valve caps
9-542503	54		CuZn	

Tube valve

Art. no.	TR no.	ETRTO no.	Length (mm)	Vehicle type	Material	Valve caps
9-534043	218A	V4.O1.1	47		CuZn	

Snap-in agricultural valve

Art. no.	Length (mm)	Vehicle type	Material	Valve caps
9-594012	55		CuZn	



9-544501



9-544503
9-544543

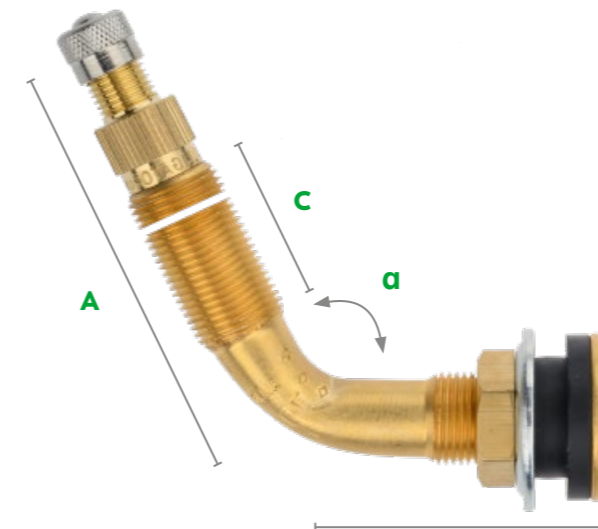

9-545503
9-547503

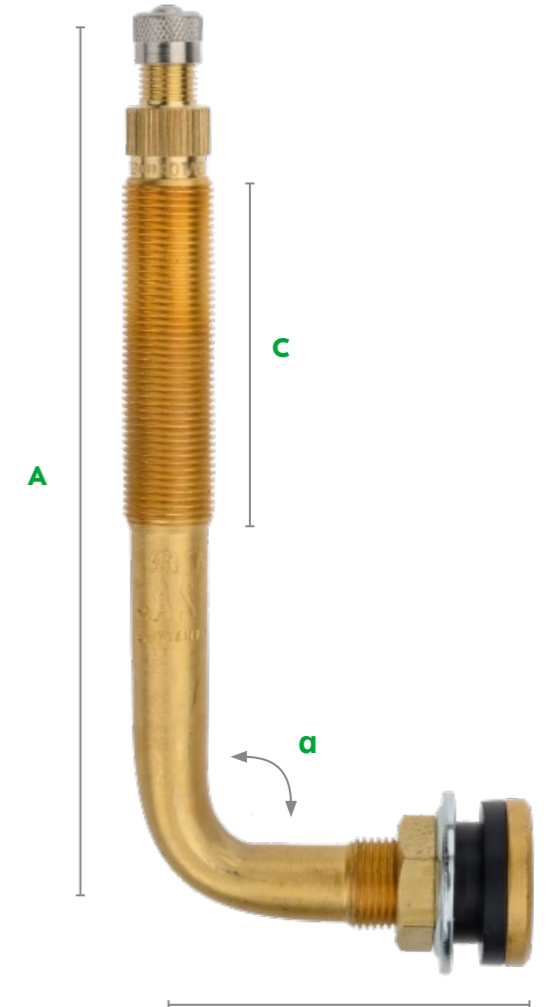

9-546503

Tubeless valves

Art. no.	TR no.	ETRTO no.	A (mm)	B (mm)	Bending angle a (°)	C (mm)	Vehicle type	Material	Valve caps
9-544543	618Aeq		40					CuZn	
9-544503	618A	V5.15.1	51					CuZn	
9-544501	618A	V5.15.1	51					CuZn	
9-547503	623A	V5.15.4	57	42.5	65	36.5		CuZn	
9-545503	621A	V5.15.2	75	42.5	65	55.0		CuZn	
9-546503	622A	V5.15.3	115	48.0	90	94.5		CuZn	

ACCESSORIES

For agricultural valves



9-324703 9-324701 9-324603

Valve cores

Art. no.	TR no.	ETRTO no.	Length (mm)	Vehicle type	Material	Surface	Valve caps
9-324703	CH3	V4.02.1	35.5		CuZn	-	
9-324701	CH3	V4.02.1	35.5		CuZn	-	
9-324603	CH1		40.0		CuZn	Ni	



9-322200 9-322215

Rim nuts

Art. no.	TR no.	ETRTO no.	Thread	Vehicle type	Material	Surface
9-322200	LN10	V9.14.1	12V1		CuZn	-
9-322215	LN10	V9.14.1eq	12V1		Plastic	-

WATER FILLING AND EMPTYING DEVICES

For easy filling of tractor tires



9-339182 9-339101



9-339181



9-339051 9-339251 9-339002 9-033365

Water filling and emptying devices

Art. no.	Description	Vehicle type	Material	Surface
9-339182	Combined water filling and emptying devices (Hanauer Mouse)		CuZn	Ni
9-339181	Combined water filling and emptying devices (Waterboy G3/4)		CuZn	Ni
9-339101	Air/water fittings		CuZn	Ni
9-339091	Adapter set G3/4 + 12V1		CuZn	Ni
9-033365	Hose coupling 1/3		CuZn	-
9-339002	ZW air/water adapter		CuZn	Ni
9-339051	Adapter		CuZn	Ni
9-339251	Adapter		CuZn	-

ASSEMBLY INSTRUCTION

WATER FILL- & EMPTYING DEVICE

Filling the driving wheels

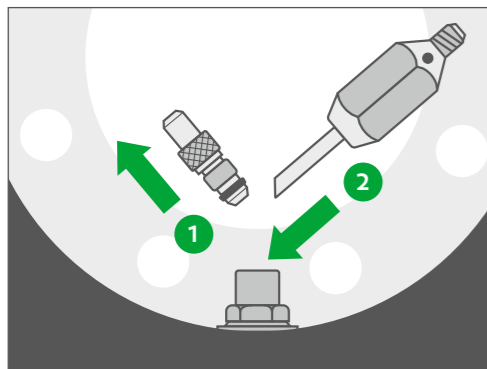

- Jack up the driving wheel.
- Unscrew valve core housing 1 from the rim valve.
- Allow compressed air to escape.
- Screw water filling valve on 2.

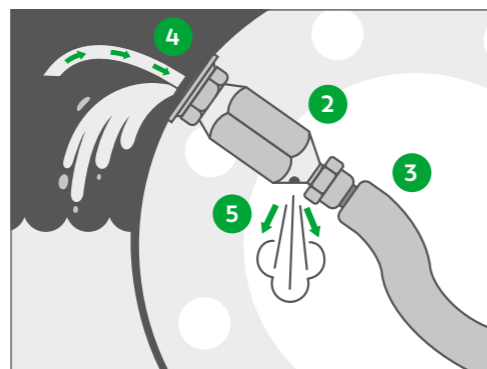

- Set driving wheel to position 2.
- Connect water hose 3 and fill with water.
- Air escapes from the tires through the tube 4 and the opening 5.
- Tire is sufficiently filled with water, if water flows out of opening 5.

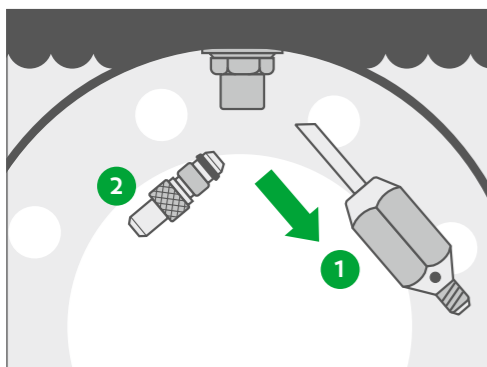

- Set driving wheel to position 3.
- Unscrew water filling valve 1.
- Screw in valve core housing 2.

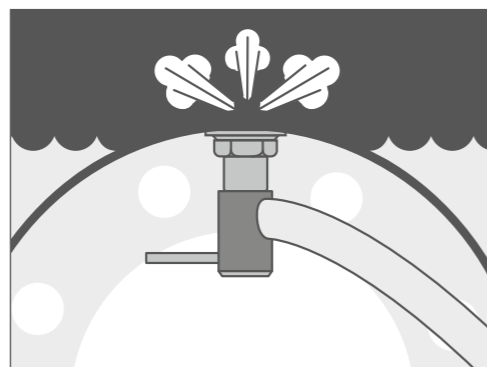

- Fill tires with compressed air according to instructions.
- Store water filling valve in a safe place.

Emptying the driving wheels

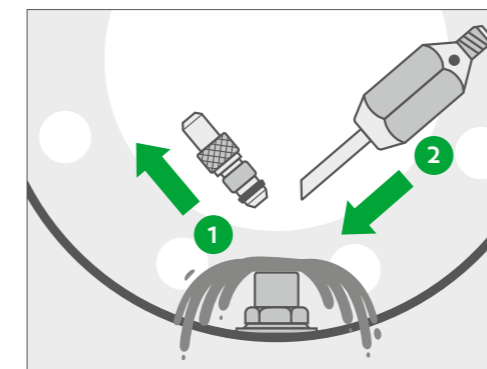

- Jack up the driving wheel.
- Unscrew valve core housing 1 from the rim valve.
- Drain water.
- Screw in water filling valve 2.

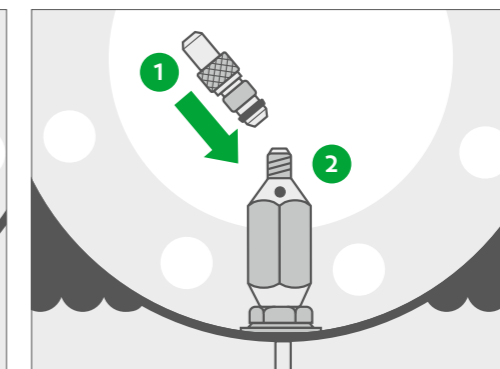

- Screw valve core housing 1 into water filling valve 2.

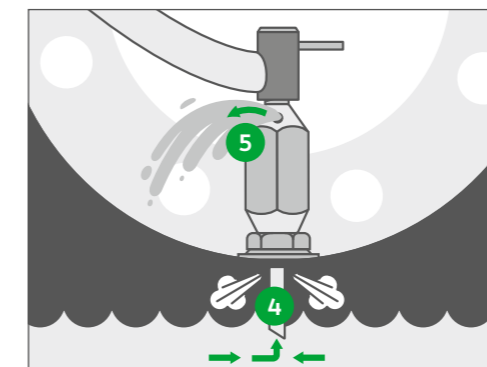

- Fill with compressed air.
- Air from tires escapes through tube 4 and water through opening 5.

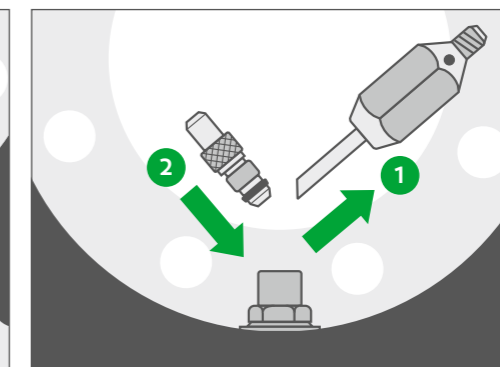

- Unscrew water filling valve 1.
- Screw in valve core housing 2.
- Fill tires with compressed air according to instructions.
- Store water filling valve in a safe place.

EARTHMOVER VALVES



For earthmoving equipment, heavy-duty trucks, high-capacity dump trucks, dumpers, loaders, conveyors, graders, and cranes.

CONTENT

Large bore valves	88
Large bore valves with base	90
Large bore valve extensions	92
Accessories	95

LARGE BORE VALVES

Without rim base

- **Application:** For rim valves on tubeless EM tires
- **Design:** Without base
- **Valve hole:** 20 + 0.5 mm



9-820061

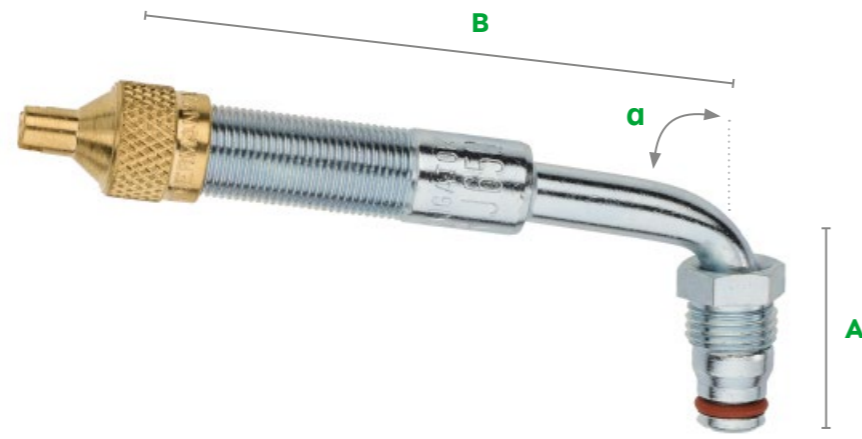

9-820161

Large bore valves

Without protective tube

Art. no.	TR no.	ETRTO no.	A (mm)	B (mm)	Bending angle α (°)	Qty	Vehicle type	Material	Surface	Valve caps
9-820061	J670-02	V5.03.1	41			10		CuZn	-	
9-820146	J653-02		27	64	80	10		CuZn	NI	
9-820141	J4000-2 1/2		27	64	90	10		CuZn	NI	
9-820166	J654-02		27	80	60			CuZn	NI	
9-820176	J655-02		27	80	74	10		CuZn	NI	
9-820161	J650-02	V5.04.1	27	80	80	10		CuZn	NI	
9-820171	J4000-3 1/8		27	80	90			CuZn	NI	
9-820191	J659-02		48	89	90			CuZn	NI	

Tightening torque: 8-9 Nm

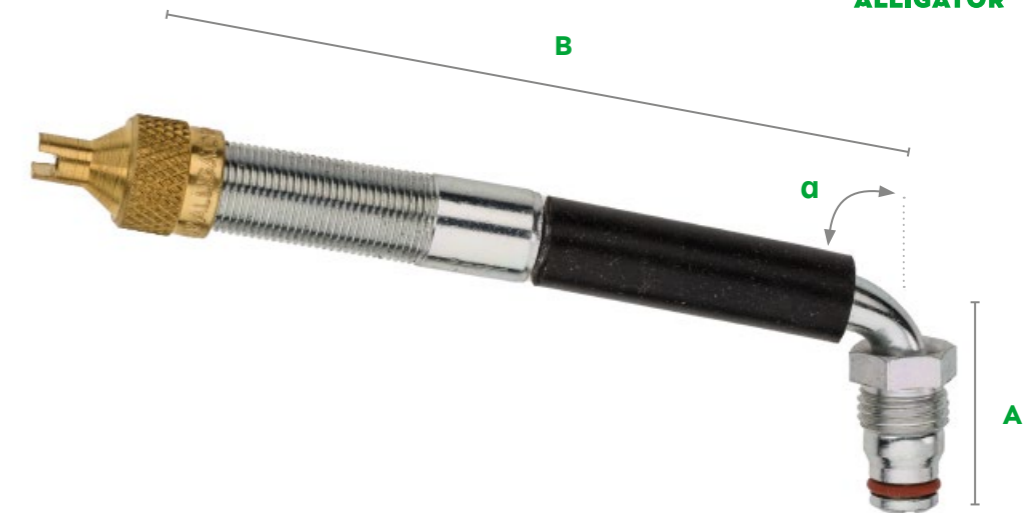

9-820226

Large bore valves

With protective tube

Art. no.	TR no.	ETRTO no.	A (mm)	B (mm)	Bending angle α (°)	Vehicle type	Material	Surface	Valve caps
9-820201	J657-02		27	100	80		CuZn	NI	
9-820226	J4000-4 1/2		27	115	90		CuZn	NI	
9-820236	J651-02	V5.04.2	32	119	90		CuZn	NI	
9-820266	J658-02		27	140	80		CuZn	NI	
9-820261	J652-02		27	140	86		CuZn	NI	
9-820286 *	J4000-6		27	153	90		CuZn	NI	
9-820341 *	J4000-71/2		27	191	90		CuZn	NI	
9-820381 *	J4000-83/4		27	222	90		CuZn	NI	

* with two hex nuts

Tightening torque: 8-9 Nm



EM valve spud

Art. no.	TR no.	ETRTO no.	A (mm)	Qty	Vehicle type	Material	Surface
9-329201	SP2	V5.10.1	17	10		CuZn	-

Tightening torque: 20-23 Nm

Spare part

Art. no.	Description	Vehicle type	Material
9-030739	Rubber grommet		VMQ70



LARGE BORE VALVES

With rim base

- **Application:** For rim valves on tubeless EM tires
- **Design:** With base

- **Valve hole:** 20 + 0.5 mm
- **Installation torque:** 20–23 Nm

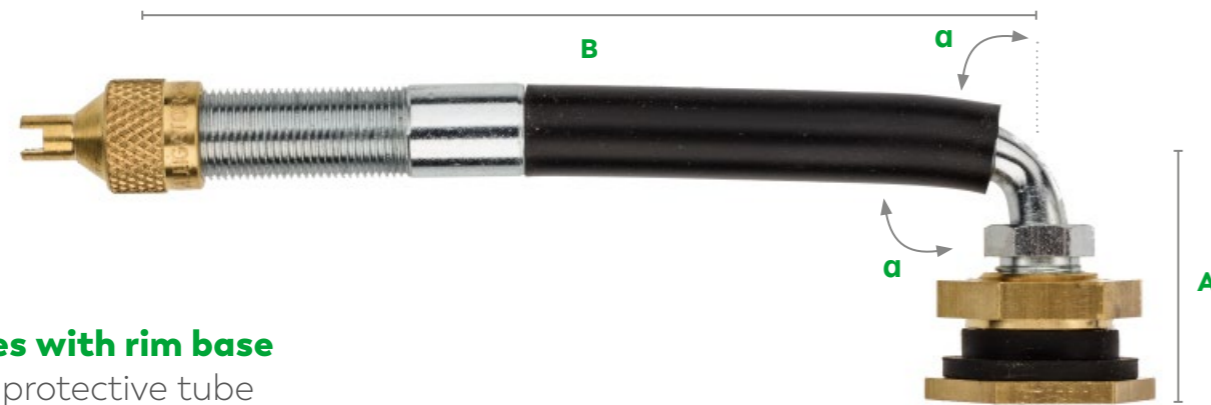

Valves with rim base

With protective tube

Art. no.	TR no.	A (mm)	B (mm)	Bending angle α (°)	Qty	Vehicle type	Material	Surface	Valve caps
9-830236	J651-03	32	119	90	10		CuZn	Ni	
9-830266	J658-03	27	140	80			CuZn	Ni	
9-830261	J652-03	27	140	86	10		CuZn	Ni	

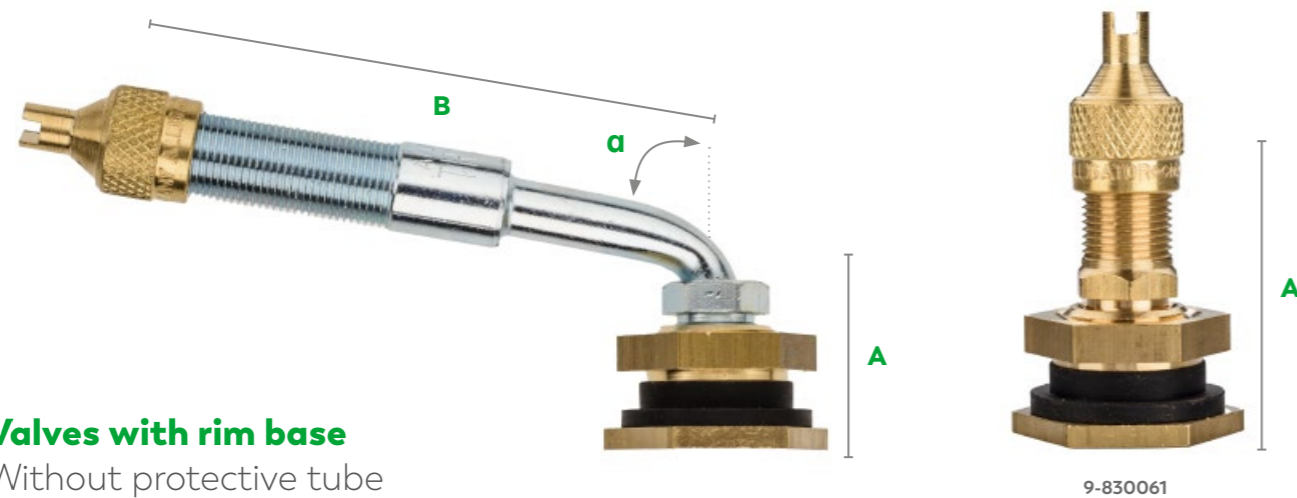

Valves with rim base

Without protective tube

Art. no.	TR no.	A (mm)	B (mm)	Bending angle α (°)	Vehicle type	Material	Surface	Valve caps
9-830061	J670-03	41				CuZn	-	*
9-830146	J653-03	27	64	80		CuZn	Ni	
9-830166	J654-03	27	80	60		CuZn	Ni	
9-830176	J655-03	27	80	74		CuZn	Ni	
9-830161	J650-03	27	80	80		CuZn	Ni	*

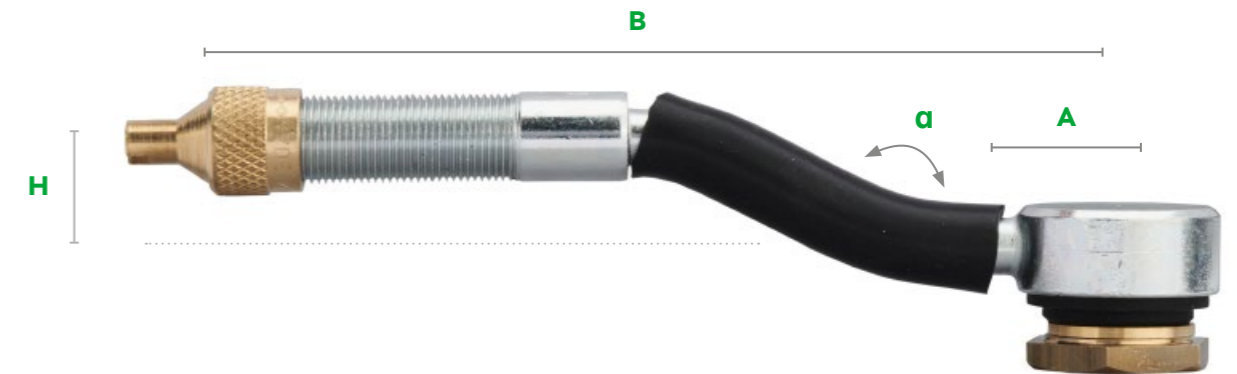

Valve EM large bore turret

With protective tube

Art. no.	TR no.	ETRTO no.	A (mm)	B (mm)	H (mm)	Bending angle α (°)	Qty	Vehicle type	Material	Surface	Valve caps
9-850167*	J695		20	105	25	50	10		CuZn	Ni	
9-850191	J690	V5.05.1	32	119	14	28	10		CuZn	Ni	

* Screw driver valve cap 8V1 with adapter

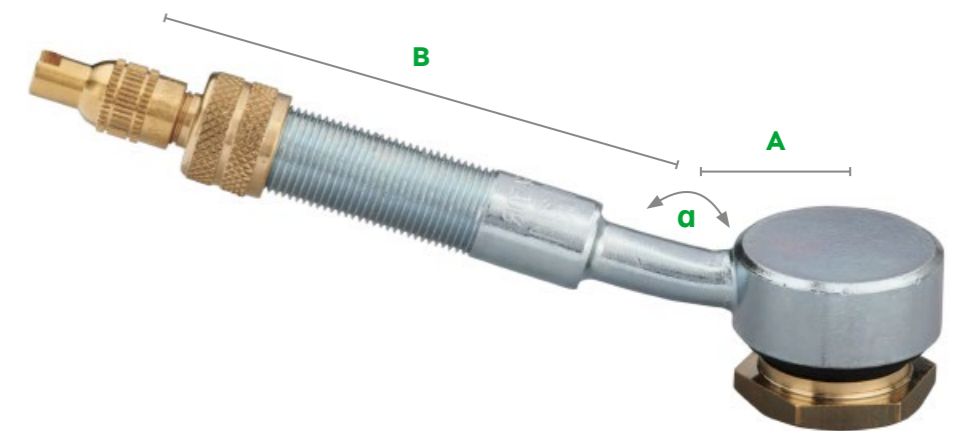

Valve EM large bore

Without protective tube

Art. no.	TR no.	ETRTO no.	A (mm)	B (mm)	Bending angle α (°)	Qty	Vehicle type	Material	Surface	Valve caps
9-850131	J691	V5.09.1	20	65	18	10		CuZn	Ni	
9-850121	J694		20	70	28	10		CuZn	Ni	
9-850154*			20	95	22	10		CuZn	Ni	

* Screw driver valve cap 8V1 with adapter

LARGE BORE VALVE EXTENSIONS

For difficult to access EM large bore valves

Brass

Rigid



With support collar

Art. no.	Total length (mm)	Eff. extension (mm)	Wrench size	Vehicle type	Valve caps
9-340241	82	64	14		
9-340331	104	86	14		
9-340401	120	102	14		
9-340441	132	114	14		
9-340501	145	127	14		
9-340541	159	141	14		

Rubber

Highly flexible



Rubber

Art. no.	Total length (mm)	Eff. extension (mm)	Wrench size	Vehicle type	Valve caps
9-350641	140	121	16		
9-350661	160	141	16		
9-350721	180	161	16		
9-350771	210	191	16		
9-351071	275	256	16		
9-351171	300	281	16		
9-351241	320	301	16		
9-351411	360	341	16		
9-351641	420	401	16		
9-351871	480	461	16		
9-352171	555	536	16		
9-352421	615	596	16		
9-352711	689	670	16		
9-352801	710	691	16		

Max. operating pressure: Up to 10 bar / 145 psi

Rubber with steel braid

Flexible



Rubber with steel braid

Art. no.	Total length (mm)	Eff. extension (mm)	Wrench size	Vehicle type	Valve caps
9-350671	140	121	16		
9-351242	320	301	16		
9-351971	480	461	16		
9-352071	555	536	16		
9-352422	615	596	16		

Max. operating pressure: Up to 20 bar / 290 psi

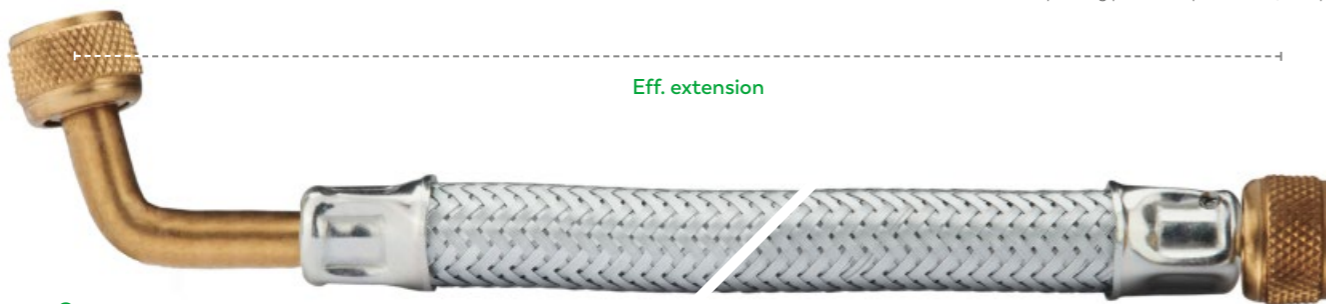

75° angle

Art. no.	Eff. extension (mm)	Vehicle type
9-356070	200	

Max. operating pressure: Up to 20 bar / 290 psi



Special item

Art. no.	Description	Eff. extension (mm)	Vehicle type
9-290090	Tube extension (two 12V1)	292.5	

Max. operating pressure: Up to 20 bar / 290 psi

ACCESSORIES

For EM large bore valves



9-305000

9-304000

9-304500

Valve caps

Art. no.	Description	TR no.	Vehicle type	Material	Surface	Valve caps
9-305000	EM large bore screw driver valve caps 8V1	VC4		CuZn	-	
9-304000	EM large bore screw driver valve caps 12V1	VC6		CuZn	-	
9-304500	EM large bore valve cap hex	VC7		CuZn	-	



9-319900

9-033245

Valve cores

Art. no.	Description	TR no.	Length (mm)	Vehicle type	Material	Surface
9-319900	EM large bore valve core short	C2	21		CuZn	Ni
9-033245	EM large bore valve core short	C2	28		CuZn	Ni



9-338501 9-338601

Adapter / Reducer

Art. no.	TR no.	Pump connector	Valve connector	Vehicle type	Material	Surface
9-338501		8V1 (car)	12V1 (EM)		CuZn	-
9-338601	AD1	8V1 (car)	8V1 (car)		CuZn	-



Thumb-lock air chuck for 12V1 (large bore valves)

Art. no.	Connection diameter (mm)	Tube inner diameter (mm)	Vehicle type	Material	Surface
9-142700	7	6		CuZn	Ni
9-142800	9	8		CuZn	Ni



9-143400

Clip-on air chuck for 12V1 (large bore valves)

Art. no.	Variant	Connection diameter (mm)	Tube inner diameter (mm)	Vehicle type	Material
9-143400	open end	8	7		CuZn



Tool

Art. no.	Description	Total length (mm)	Vehicle type
9-230700	Valve fishing tool 12V1	315	

APPLICATION OF THE VALVE FISHING TOOL

- Insert the head of the valve fishing tool through the hole and screw it onto the valve.
- Designed to assist valve hole location when fitting tubes.
- The handle can also be used as a screwdriver for standard valve cores.

MOTORCYCLE VALVES



Valves come in all shapes and sizes. Discover the ALLIGATOR range of motorcycle valves.

CONTENTS

Valve hole 8.3..... 100

Valve hole 11.3 102

Valve hole 8.3 + 0.3 mm



Brass valves

Art. no.	TR no.	ETRTO no.	Length (mm)	Wrench size	Installation torque (Nm)	Qty	Vehicle type	Material	Surface	Valve caps
9-447413			25	11	7-10	20		CuZn	Ni	
9-511992			26	11	5-7	20		CuZn	Ni	
9-511003			33	10	3-5	20		CuZn	Ni	
9-447513	430eq	V1.10.1	34	11	7-10	20		CuZn	Ni	
9-511993			39	11	5-7	20		CuZn	Ni	

Maximum working pressure: 14 bar / 200 psi

Aluminum valves



Art. no.	ETRTO no.	Length (mm)	Wrench size	Bending angle (°)	Installation torque (Nm)	Qty	Vehicle type	Material	Surface	Valve caps
9-447500	V1.10.2	24	12	80	7-10	20		Al	Elox	
9-447505	V1.10.2	24	12	80	7-10	20		Al	Elox	

Maximum working pressure: 14 bar / 200 psi
Only use with nickel-plated valve core to avoid contact corrosion!



Tube valves - straight

Art. no.	TR no.	Length (mm)	Wrench size	Qty	Vehicle type	Material	Surface	Valve caps
9-410503	4EQ	33.5	10	20		CuZn	Ni	
9-440003		43	10	20		CuZn	Ni	

Maximum working pressure: 7 bar / 100 psi

Spare part for 9-440003

Art. no.	Description	Material	Surface
9-321800	Spare part for tube valves	CuZn	Ni



Valve hole 11.3 + 0.4 mm



Brass valves for scooters

Art. no.	Bending angle (°)	Installation torque (Nm)	Qty	Vehicle type	Material	Surface	Valve caps
9-520944	90	7-10	100		CuZn	-	

Maximum working pressure: 4,5 bar / 65 psi
Maximum speed limit: 80 km/h / 50 mph



9-521515

9-521545

Rubber valves for motorcycles

Art. no.	TR no.	ETRTO no.	Length (mm)	Qty	Vehicle type	Material	Surface	Valve caps
9-521515	412	V2.03.06	33	100		CuZn	-	
9-521527	412 unmounted	V2.03.06	33	100		CuZn	-	
9-521545	412	V2.03.06	33	100		CuZn	-	

Maximum working pressure: 4,5 bar / 65 psi



9-447512



9-447515

Aluminum valves

Art. no.	ETRTO no.	Length (mm)	Wrench size	Bending angle (°)	Installation torque (Nm)	Qty	Vehicle type	Material	Surface	Valve caps
9-447512	V2.03.15	25	14	80	3-5	20		Al	Elox	
9-447515	V2.03.15	25	14	80	3-5	20		Al	Elox	

Maximum working pressure: 14 bar / 200 psi
Only use with nickel-plated valve core to avoid corrosion!



Tube valves

Art. no.	TR no.	Length (mm)	Bending angle (°)	Qty	Vehicle type	Material	Surface	Valve caps
9-445011	88	38	90	20		CuZn	-	

Maximum working pressure: 7 bar / 100 psi

BICYCLE VALVES

With the invention of the express valve, ALLIGATOR had a huge impact on the cycling world. Now it has an exciting new development in the range: the further developed universal express valve.

CONTENT

Express valve (Dunlop)	106
Universal express valve.....	108
Presta valve (Presta).....	110
Air pump valve adapter.....	111
Universal service station air chuck	112
Rotatable tire inflator.....	114



EXPRESS VALVE (DUNLOP)

The original

- **Application:** Trekking bikes, fitness bikes, city bikes
- **Rim hole:** 8.5 mm
- **Operating pressure:** Up to 6 bar / 87 psi
- **Air pump:** Bicycle pump (or use adapter)

ADVANTAGES

- Inflate tires effortlessly
- Excellent seal retention
- High quality, exceptionally long service life

Express valve feature

How does the express valve work?

- The rim nut holds the express valve securely in the valve body.
- The outer seal prevents the air compressed in the tire from escaping between the express valve and the valve body.
- The excess pressure in the bicycle tire forces the non-return element into place.
- The fill opening of the express valve is closed securely.

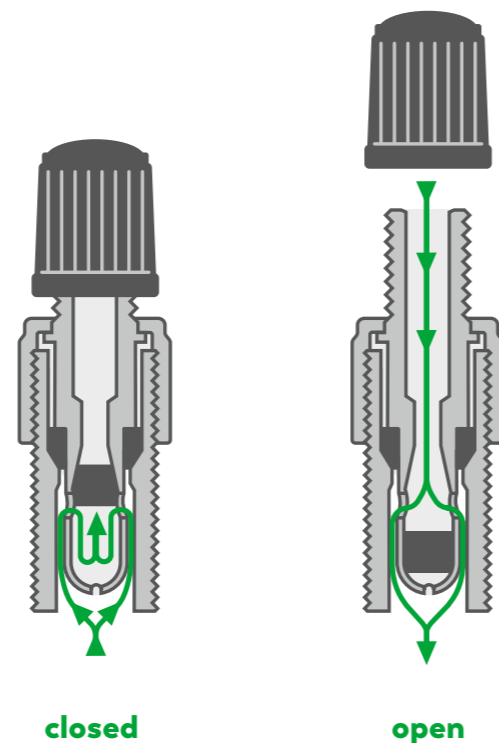

Express valve

Art. no.	Description	Vehicle type	Material	Surface	Valve caps
9-110000	Express valve (without cap)		CuZn	Ni	-
9-110010	Express valve		CuZn	-	
9-110001	Express valve		CuZn	Ni	
9-110002	Express valve (incl. counter display)		CuZn	Ni	

Express valve with rim nut



Art. no.	Vehicle type	Material	Surface	Valve caps
9-110215		CuZn	-	
9-110201		CuZn	Ni	

UNIVERSAL EXPRESS VALVE

One valve suitable for all bicycles

- **Application:** Suitable for all bikes
- **Rim hole:** Variable applications
- **Operating pressure:** Up to 15 bar / 218 psi
- **Air pump:** Bicycle pump (or use adapter)

Advanced dual-seal design allows universal application

- Prevents gradual air leakage.
- High-pressure resistance thanks to two-stage cone seal.

ADVANTAGES

- Universal application
- Can also withstand "racing bike" pressure
- Inflate tires effortlessly
- Excellent seal retention
- High quality, exceptionally long service life

Simple application:

No more struggling to sort through all the different types of bicycle valves

- Universal high-pressure valve core.
- Use the appropriate rim nut for car and express valve.
- Fits all commercially available valve bodies, tubes and rim holes*.

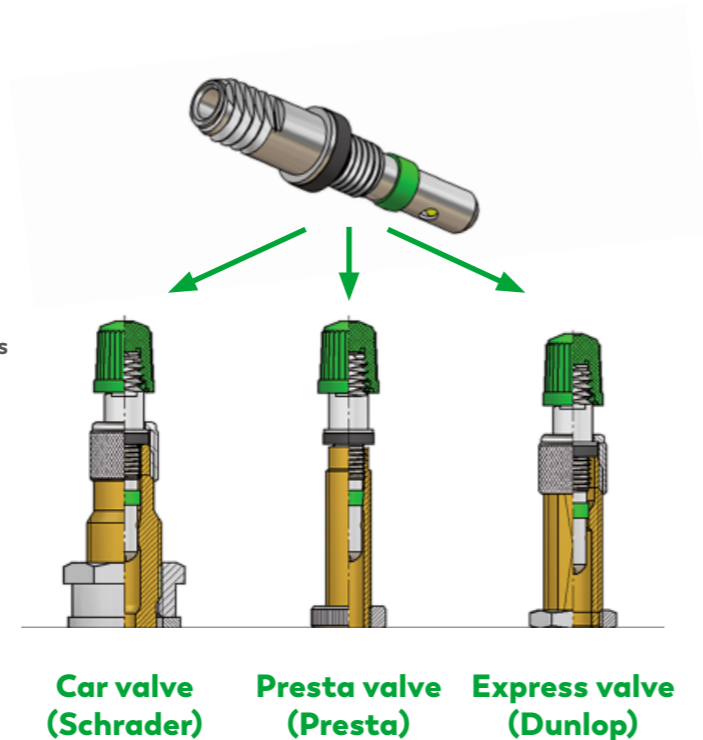

Car valve (Schrader)

Presta valve (Presta)

Express valve (Dunlop)

* not suitable for Dunlop stem with side slits.



Universal express valve

Art. no.	Description	Vehicle type	Material	Surface	Valve caps
9-111002	Universal express valve		CuZn	Ni	

Accessories

Express valve/universal express valve



9-049151

9-049157

Valve caps

Art. no.	Color	Vehicle type	Material	Valve caps
9-049151	Black		Plastic	
9-049157	Green		Plastic	



9-105000

9-105300

Rim nuts

Art. no.	Description	Vehicle type	Material	Surface
9-105000	Union nut VG7.8 (for express valve body)		CuZn	Ni
9-105300	Union nut 8V1 (for car valve body)		CuZn	Ni

PRESTA VALVE (SCLAVERAND)

Ideal for narrow rims

- **Application:** Racing bike, mountain bike, tubeless
- **Rim hole:** 6.5 mm
- **Operating pressure:** Up to 15 bar / 218 psi
- **Air pump:** Bicycle pump (or use adapter)

ADVANTAGES

- High pressure resistance up to 15 bar
- Air pressure readable using floor pump
- Air pressure can be precisely adjusted
- Thin rim hole ensures high stability



Valves

Art. no.	Description	ETRTO no.	Vehicle type	Material	Surface	Valve caps
9-033180	Presta valve (without cap)			CuZn	Ni	-
9-033181	Presta valve spare parts set			CuZn	Ni	
9-121004	Presta valve bicycle tube valve	V1.01.2		CuZn	Ni	

Accessories

Art. no.	Description	ETRTO no.	Vehicle type	Material	Surface
9-031205	Presta valve cap – black	V9.04.1		Plastic	-
9-033182	Tool for Presta valves			Plastic	-
9-124599	Rim nut for Presta valve 6V1	V9.03.1		CuZn	Ni

AIR PUMP VALVE ADAPTER

For inflating bicycle tires – versatile use



Adapter

Art. no.	Description	Valve connector	Pump connector	Vehicle type	Material	Surface
9-138800	Adapter with built-in check valve and valve pin	Car	Express valve		CuZn	Ni
9-138600	Adapter with seal	Car	Express valve		CuZn	-
9-138300	Adapter	Express & Presta valve	Car		CuZn	-
9-138100	Adapter with seal	Express valve	Car		CuZn	-
9-138900	Adapter	Presta valve	Express valve		CuZn	-
9-139000	Adapter with seal	Presta valve	Express valve		CuZn	-



Accessories for inflating equipment for express valve

Art. no.	Description	Vehicle type	Material	Surface
9-133201	Bicycle clip valve plug nipple 8/7		CuZn	Ni
9-132611	Plug-in transition nipple with safety chain*		CuZn	Ni

*Suitable for connection with thunder-lock air chuck for motor vehicles..

UNIVERSAL SERVICE STATION AIR CHUCK

For Presta, express and car valves



For automotive & bicycle valves (Presta & express valves)

Closed end

Art. no.	Connection type	Length (mm)	Connector diameter (mm)	Hose inner diameter (mm)	Vehicle type	Material	Surface
9-148500	Female thread R1/4	175				CuZn	Ni
9-148600	Hose connection 8/7	175	8	7		CuZn	Ni



Spare parts

Art. no.	Description	Material	Surface
9-030709	Rubber grommet (motor vehicle and bicycle side)	Rubber	-
9-030722	Rubber grommet (bicycle side)	Rubber	-
9-032114	Steel pressure spring	Fe	-
9-131512	Cover (bicycle side)	CuZn	Ni
9-148520	Connection (bicycle side)	CuZn / Rubber	Ni / -
9-146011	Cover (motor vehicle side)	CuZn	Ni
9-146020	Deflator pin (motor vehicle and bicycle side)	CuZn	-



For automotive & express valves

Closed end

Art. no.	Connection type	Length (mm)	Connector diameter (mm)	Hose inner diameter (mm)	Vehicle type	Material	Surface
9-148100	Hose connection 8/7	260	8	7		CuZn	Ni
9-148200	Female thread R1/4	250				CuZn	Ni



Spare parts

Art. no.	Description	Material	Surface
9-030709	Rubber grommet (motor vehicle side)	Rubber	-
9-030723	Rubber grommet (bicycle side)	Rubber	-
9-032114	Steel pressure spring	Fe	-
9-146010	Cover (motor vehicle side)	CuZn	Ni
9-146020	Deflator pin (motor vehicle side)	CuZn	-
9-148010	Cover (bicycle side)	CuZn	Ni
9-148020	Deflator pin (bicycle side)	CuZn	-

ROTATABLE TIRE INFLATOR

For bicycle and car valves



FLEXIBILITY IN ALL ASPECTS

- Revolving connection, valve can be filled in every position.
- Fast tool change possible due to quick connector. Shockproof and robust plastic housing.
- Readability of the pressure gauge ensured in any valve position.

Rotatable tire inflator

Open End

Art. no.	Description	Vehicle type
9-149980	Rotatable tire inflator with rapid coupling	★
9-149979	Rotatable tire inflator with rapid coupling (for Switzerland)	



9-030469



9-149981



9-149978

Accessories for rotatable tire inflator

Art. no.	Description	Vehicle type	Material	Surface
9-030469	Manometer	-	-	-
9-149981	Rotatable connector G1/4		CuZn	Ni ★
9-149978	Piston - complete (spare part for 9-149979 + 9-149980)	-	Plastic	-



Spare parts

Art. no.	Description	Material	Surface
9-030709	Rubber grommet (motor vehicle & bicycle side)	Rubber	-
9-030722	Rubber grommet (bicycle side)	Rubber	-
9-131512	Cover (bicycle side)	CuZn	Ni
9-148520	Connection set (bicycle side)	CuZn / Rubber	Ni / - ★
9-146010	Chuck nut (motor vehicle side)	CuZn	Ni
9-147120	Double deflator pin (open end)	CuZn	-

TOOLS



For the professional assembly of valves.

CONTENTS

Valve mounting tool.....	118
Rethreading tools.....	120
Valve screw driver.....	121
Other tools.....	123

VALVE MOUNTING TOOL

For efficient assembly of snap-in valves

■ **Application:** For original equipment (OE) and tire workshop

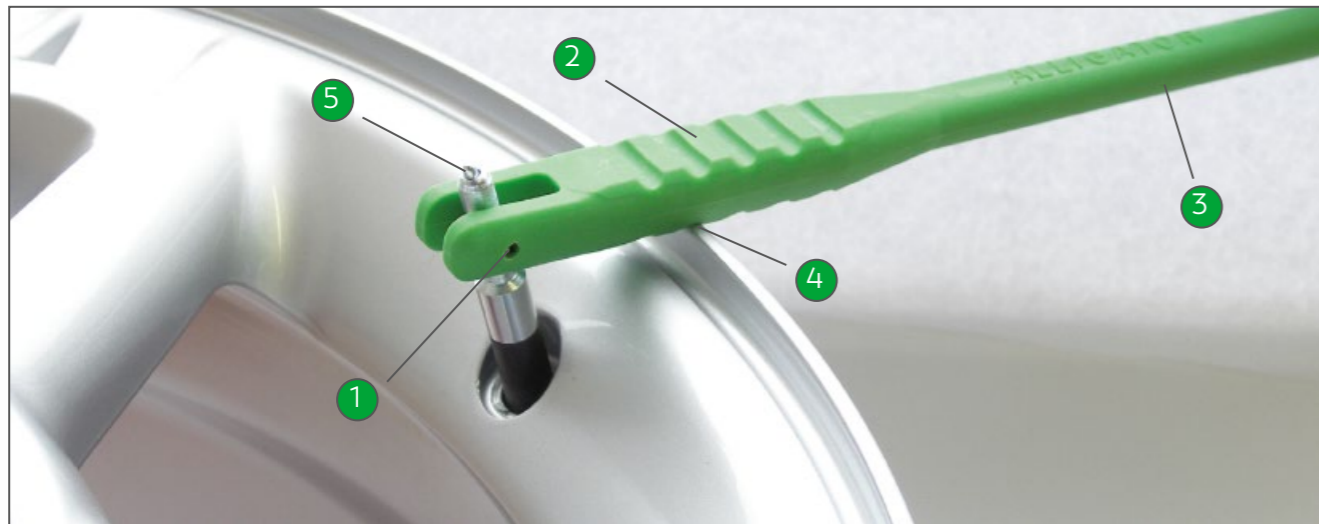

- 1 **Pivoting joint** prevents the valve from being retracted at an angle.
- 2 **Snap-in notches** ensure a correct angle.
- 3 **Long lever arm** for an optimal force application.
- 4 **Soft plastic shaft** prevents damage to aluminum wheels.
- 5 **The "click" mechanism in the head** allows rapid screwing onto the valve.



9-231900



9-231930



9-231940

Valve mounting tool

Art. no.	Description
9-231900	Standard valve mounting tool
9-231940	Valve mounting tool+ (combined with valve screw driver)

RETHREADING TOOLS

For easy and quick repair

Properties

- Facilitates and accelerates valve repair.
- Made of robust tool steel.
- Surface protected against corrosion.



9-235041

9-235061

Valve rethreader

Art. no.	Description
9-235041	Valve rethreader with Key for standard valve cores
9-235061	Valve rethreader with Key for EM valve cores



Valve rethreader

Art. no.	Description
9-235020	Four-way valve tool

VALVE SCREW DRIVER

For easy (dis)assembly of valve cores



Valve screwdriver

Art. no.	Description
9-232602	Universal valve tool
9-232640	Tool insert (valve cores and screw driver valve caps)
9-232650	Tool insert (EM large bore valve cores and screw driver valve caps)



Simple valve core screw driver

Art. no.	Intended use
9-232505	(Dis)assembly of standard valve core

Valve screwdriver



9-232500



9-232511



9-232503



9-232540

Dual valve screw driver

Art. no.	Intended use
9-232500	(Dis)assembly of standard valve core + screw driver valve cap
9-232511	(Dis)assembly of standard valve core + screw driver valve cap; with magnet
9-232503	(Dis)assembly of standard valve core + EM large bore valve core
9-232540	(Dis)assembly of standard valve core + fixing tool TPMS aluminum valves



OTHER TOOLS

Small devices – big effect

APPLICATION OF THE VALVE FISHING TOOL

- Insert the head of the valve fishing tool through the hole and screw it onto the valve.
- Designed to assist valve hole location when fitting tubes.
- The handle can also be used as a screw driver for standard valve cores.



9-230500

9-230700

Valve fishing tool

Art. no.	Description	Length (mm)
9-230500	Valve fishing tool 8V1	260
9-230700	Valve fishing tool 12V1 (EM)	315



Tread depth gauge

Art. no.	Description
9-235800	Tread depth gauge



VALVE CAPS



Valve caps are an integral part of the ALLIGATOR valve world and the basic requirement for the permanent functionality of the valve.

CONTENT

Car / truck valve caps	126
Double seal valve caps	131
Bicycle valve caps	132
EM large bore valve caps	133

CAR / TRUCK VALVE CAPS

8V1 Thread

Standard valve caps

Brass | with sealing



Art. no.	Description	TR no.	Qty	Vehicle type	Material	Surface
9-301500	Metal valve cap	VC3	100		CuZn	Ni
9-300500	Screw driver valve cap	VC2	100		CuZn	Ni
9-093032	Long metal valve cap	VC3eq	100		CuZn	Ni

Valve extension caps

Brass | with sealing



Art. no.	Length (mm)	Eff. length (mm)	Vehicle type	Material	Surface
9-330201	27	19		CuZn	Ni
9-330401	41	32		CuZn	Ni

Special valve caps

Brass | with sealing



Art. no.	Description	TR no.	ETRTO no.	Vehicle type	Material	Surface
9-300000	Screw driver valve cap with protective cap	VC2	V9.04.4		CuZn	Ni
9-031210	Protective cap for screw valve cap				Rubber	-
9-302100	Screw driver valve cap with protective tube				CuZn	Ni
9-303220	Hexagonal valve cap				CuZn	Ni

Round top valve caps

Aluminum | with sealing



Art. no.	Color	Vehicle type	Material	Surface
9-394927	Silver		Al	Elox
9-394928	Black		Al	Elox
9-394929	Titanium gray		Al	Elox

Only use on aluminum valves.

Standard valve caps (on request)

Plastic



9-093019

Art. no.	Color	TR no.	Qty	Vehicle type	Material
9-093019	Black	VC8	100		Plastic



9-300007



9-300117



9-300119



9-300118



9-300116



9-300125

With sealing

Plastic

Art. no.	Color	Qty	Vehicle type	Material
9-300007	Black	100		Plastic
9-300117	Green*	100		Plastic
9-300119	Red	100		Plastic
9-300118	Blue	100		Plastic
9-300116	Yellow	100		Plastic
9-300125	Silver	100		Plastic

* Green valve caps indicate a tire filled with nitrogen.

Valve extension caps

Plastic



9-330275

9-330301

9-330501

Art. no.	Length (mm)	Eff. length (mm)	Vehicle type	Material
9-330275	20	12		Plastic
9-330301	28	19		Plastic
9-330501	40	32		Plastic

TYRES WITH NITROGEN

Green valve caps indicate tires filled with nitrogen



BENEFITS

- Improved driving stability and dynamics
- Higher driving comfort
- Improved retention of the driving shocks
- Reduced tire wear
- Protection of tires and rims, therefore high costs avoidance
- Increased tire life
- Fuel costs reduction

NOTE

Check regularly the tire pressure even if the tires are filled with nitrogen.

DOUBLE SEAL VALVE CAPS

AIR PRESSURE TESTING & FILLING MADE EASY

NO NEED TO UNSCREW THE VALVE CAP

AIR PRESSURE EASY TO CHECK AND ADJUST

NO PRESSURE LOSS WITH DAMAGED VALVE INSERT



V2B

DS-P

DOUBLE SEAL VALVE CAPS

No unscrewing necessary

Sealing concept

- Check and adjust air pressure without unscrewing the valve cap.
- Two high-temperature seals prevent pressure loss even if the valve insert is damaged or dirty.
- Completely sealed face protects against water and dirt.

BENEFITS

- Saves time and money
- Prevents dirty fingers
- Insensitive to dirt and water
- Does not get lost
- Provides increased safety



To the DS-P explanatory video

CLICK ME



VALVE CAPS

V2B

For brass valves

Art. no.	Description	TR no.	Qty	Vehicle type	Material	Surface
9-330708	V2B valve cap	VC12	10		CuZn	Ni
9-330709	V2B valve cap	VC12	50		CuZn	Ni

Only use on brass valves.
Not suitable for motorcycles.

DS-P (Double Seal Premium)

For plastic, brass and aluminum valves

Art. no.	Description	Qty	Vehicle type	Material
9-330770	DS-P valve cap	50		Plastic

Not suitable for motorcycles.



BICYCLES VALVE CAPS

5V2 Thread



9-049151

9-0149157

For express valve

Art. no.	Color	Qty	Vehicle type	Material
9-049151	Black	100		Plastic
9-049157	Green			Plastic



9-031205

For Presta valve (Sclaverand)

Art. no.	Description	ETRTO no.	Vehicle type	Material
9-031205	Plastic valve cap	V9.04.1		Plastic

EM LARGE BORE VALVE CAPS

12V1 Thread



9-305000

9-304000

9-304500

Valve caps

Art. no.	Description	TR no.	Vehicle type	Material	Valve cap
9-305000	EM large bore screw driver valve cap 8V1	VC4		CuZn	
9-304000	EM large bore screw driver valve cap 12V1	VC6		CuZn	
9-304500	EM large bore hexagonal valve cap	VC7		CuZn	

■ Only use accessories approved by the valve manufacturer!

A weight or length increase of the valve due to unsuitable accessories can have a negative effect on your safety.

■ Use a valve cap with seal!

Only in this way the tightness of the tire can be ensured.

■ Make sure that the valve is seated correctly!

Valves should not protrude beyond the outer edge of the rim.

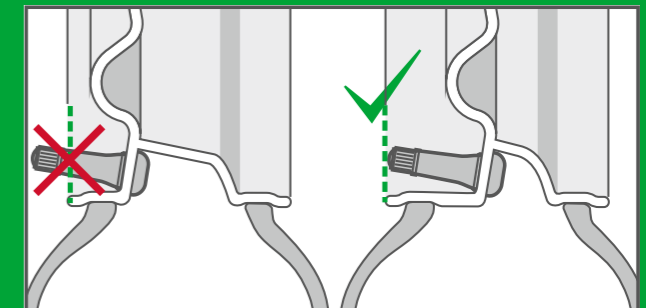

VALVE CORES

ALLIGATOR valve cores fit every application and every vehicle - with the highest quality!

CONTENT

Standard valve cores 136

EM large bore valve cores 139



VALVE CORES

For every application

Characteristics

- Protects against dirt, moisture and gradual loss of pressure
- High impermeability
- Easy to use
- High quality processing

Color coding

- For easy differentiation of valve cores in everyday work in the workshop
- No technical meaning



NOTE

- Use brass inserts only for brass valves.
- Nickel-plated inserts suitable for brass and aluminum valves.
- Recommended tightening torque: 0.23 to 0.56 Nm

Position and tolerance of the valve insert

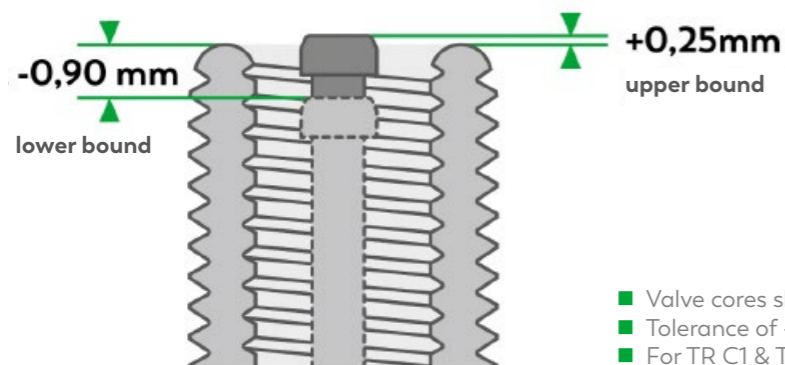

- Valve cores should be flush with the valve mouth.
- Tolerance of -0.90 and +0.25 mm is allowed.
- For TR C1 & TR C2

Standard valve cores

5V1 Thread



9-314011 9-093118

Short valve cores

Art. no.	TR no.	Length (mm)	Qty	Vehicle type	Material	Surface
9-314011	C1	16	100		CuZn	Ni
9-093118	C1	16	100		CuZn	Ni



9-093123 9-093135 9-315000
9-315500

Standard valve cores

Art. no.	TR no.	Length (mm)	Qty	Vehicle type	Material	Surface
9-093123	C1	20	100		CuZn	-
9-093135	C1	20	100		CuZn	Ni
9-315000	C1	20	100		CuZn	Ni
9-315500	C1	20	5		CuZn	Ni



9-317211 9-315150

Motorcycle

Art. no.	TR no.	Length (mm)	Qty	Vehicle type	Material	Surface
9-317211	C1	20	100		CuZn	-
9-315150	C1	20			CuZn	Ni

Reinforced spring, higher opening pressure (> 4.5 bar).

Long valve cores



Art. no.	TR no.	Length (mm)	Qty	Vehicle type	Material	Surface
9-312000	C1	33	100		CuZn	Ni
9-312500	C1	33	5		CuZn	Ni

ALLIGATOR VALVES

FOR HEAVY DUTY



Large bore valve cores

8V1 Thread



9-319900

9-033245

Large bore short valve cores

Art. no.	TR no.	Length (mm)	Vehicle type	Material	Surface
9-319900	C2	21		CuZn	-
9-033245	C2	28		CuZn	Ni



TIRE FILLING EQUIPMENT

The ALLIGATOR inflation equipment range includes a wide selection of products with which you can inflate tires and check the air pressure quickly and easily.

CONTENT

Clip-on air chucks	142
Clip-on ball foot air chucks.....	144
Thumb-lock air chucks.....	146
Service station dual foot air chucks.....	149
Tire inflators & accessories	157



CLIP-ON AIR CHUCKS

For a fast tire inflation

- **Open end:** Constantly open – even after removal from the tire valve due to subsequent pressure gauge.
- **Closed end:** Self-closing after removal from the tire valve.



Clip-on air chucks for motor vehicles

Open end

Art. no.	Connector diameter (mm)	Hose inner diameter (mm)	Vehicle type	Material	
9-143000	6	5		CuZn	★
9-142999	7	6		CuZn	★
9-143100	8	7		CuZn	★



Clip-on air chuck for motor vehicles

Closed end

Art. no.	Connector diameter (mm)	Hose inner diameter (mm)	Vehicle type	Material	Surface
9-143350	8	7		CuZn	Ni



EM large bore clip-on air chuck

Open end

Art. no.	Connector diameter (mm)	Hose inner diameter (mm)	Vehicle type	Material
9-143400	8	7		CuZn



Accessories for 9-143400

Art. no.	Description	Material
9-033401	Replacement seal	Rubber

CLIP-ON BALL FOOT AIR CHUCKS

For an easy connection of the tire filler with the valve

- **Open end:** Constantly open – even after removal from the tire valve due to subsequent pressure gauge.
- **Closed end:** Self-closing after removal from the tire valve.



With clip | for hose connection

Open end

Art. no.	Connector diameter (mm)	Hose inner diameter	Vehicle type	Material	Surface
9-143976	6	5		CuZn	Ni



With clip | for hose connection

Closed end

Art. no.	Connector diameter (mm)	Hose inner diameter (mm)	Vehicle type	Material	Surface
9-144051	6	5		CuZn	Ni
9-144151	8	7		CuZn	Ni
9-144171	9	8		CuZn	Ni

With no clip | for hose connection

Closed end



Art. no.	Connector diameter (mm)	Hose inner diameter (mm)	Vehicle type	Material	Surface
9-144001	6	5		CuZn	Ni
9-133201*	8	7		CuZn	Ni
9-144101	8	7		CuZn	Ni

* Special version for express valves



With no clip | for female thread

Closed end

Art. no.	Female thread	Vehicle type	Material	Surface
9-145451	1/4-18NPT		CuZn	Ni
9-145651	R 1/4		CuZn	Ni

Spare part for clip-on ball foot air chucks



Art. no.	Description	Material
9-030707	Replacement seal	Rubber

THUMB-LOCK AIR CHUCKS

For an easy & safe tire filling



Standard for motor vehicles

Art. no.	Connector diameter (mm)	Hose inner diameter (mm)	Vehicle type	Material	Surface
9-142200	6	5		Fe	Zn



Extra robust for motor vehicles

Art. no.	Connector diameter (mm)	Hose inner diameter (mm)	Vehicle type	Material	Surface	
9-142300	5,5	4,5		CuZn	Ni	★
9-142400	7	6		CuZn	Ni	★
9-142500	9	8		CuZn	Ni	★



Standard with releasable screw connection for motor vehicles

Art. no.	Connector diameter (mm)	Hose inner diameter (mm)	Vehicle type	Material	Surface
9-143501	10	4,5		CuZn	Ni
9-143505	14	5		CuZn	Ni



Spare parts for extra robust & standard with releasable screw connection for motor vehicles

Art. no.	Bezeichnung	Material	Surface	
9-030717	Rubber seal	Rubber	-	
9-033030	Deflator	Fe	Zn	★
9-142310	Chuck nut for thumb-lock air chuck	CuZn	Ni	★



Tube deflator for motor vehicles

Art. no.	Connector	Vehicle type	Material	Surface
9-234300	Car (8V1)		CuZn	Ni

- Complete and quick air removal (Venturi effect).
- Compatible with any type of automotive air chuck.
- Strongly recommended for repair shops.

VENTURI EFFECT

- The air in the tire/tube is sucked out by the air flowing through the cross tube.
- Deflation is accelerated.



EM large bore thumb-lock air chucks

Art. no.	Connector diameter (mm)	Hose inner diameter (mm)	Vehicle type	Material	Surface
9-142700	7	6		CuZn	Ni
9-142800	9	8		CuZn	Ni

SERVICE STATION DUAL FOOT AIR CHUCKS

For filling valves that are difficult to access



CLOSED END - Green handle

Self-closing after removal from tire valve

OPEN END - Black handle

Permanently open after removal from the tire valve

CLOSED END

open



closed



OPEN END

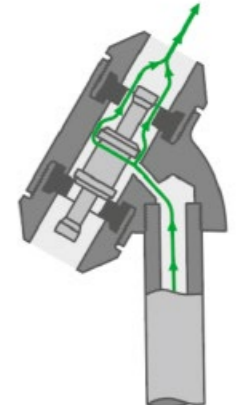

Service station dual foot air chucks

For external thread 8V1



With no handle

Art. no.	Variation	Length (mm)	Vehicle type	Material	Surface
9-146000	■ closed end	200		CuZn	Ni
9-147000	■ open end	230		CuZn	Ni



Straight

Art. no.	Variation	Length (mm)	Vehicle type	Material	Surface
9-146502	■ closed end	360		CuZn	Ni
9-147102	■ open end	360		CuZn	Ni



Bended

Art. no.	Variation	Length (mm)	Vehicle type	Material	Surface
9-146400	■ closed end	305		CuZn	Ni
9-147600	■ open end	305		CuZn	Ni

Service station dual foot air chucks

For female thread R1/4



With no handle

Art. no.	Variation	Length (mm)	Vehicle type	Material	Surface
9-147020	■ open end	170		CuZn	Ni



Straight

Art. no.	Variation	Length (mm)	Vehicle type	Material	Surface
9-146700	■ closed end	345		CuZn	Ni

9-148200



9-148500



Straight - combined version

Art. no.	Variation	Length (mm)	Vehicle type	Material	Surface
9-148200*	■ closed end	250		CuZn	Ni
9-148500**	■ closed end	175		CuZn	Ni

* Combined version for tire valves of motor vehicles and bicycles (express and Presta valves).
 ** Combined version for tire valves of motor vehicles and bicycles (express valves).



Bended

Art. no.	Variation	Length (mm)	Vehicle type	Material	Surface
9-146420	■ closed end	290		CuZn	Ni

Service station dual foot air chucks

For hose connection



Straight

Art. no.	Variation	Length (mm)	Connector diameter (mm)	Hose inner diameter (mm)	Vehicle type	Material	Surface
9-146600	■ closed end	350	8	7		CuZn	Ni
9-147200	■ open end	350	8	7		CuZn	Ni
9-146602	■ closed end	350	8	7		CuZn	Ni
9-147202	■ open end	355	8	7		CuZn	Ni

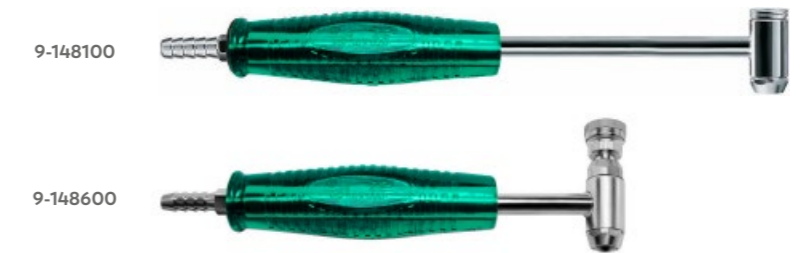

Straight - combined version

Art. no.	Variation	Length (mm)	Connector diameter (mm)	Hose inner diameter (mm)	Vehicle type	Material	Surface
9-148100*	■ closed end	260	8	7		CuZn	Ni
9-148600**	■ closed end	175	8	7		CuZn	Ni

* Combined version for tire valves of motor vehicles and bicycles (express valves).
 ** Combined version for tire valves of motor vehicles and bicycles (express and Presta valves).

Bended



Art. no.	Variation	Length (mm)	Connector diameter (mm)	Hose inner diameter (mm)	Vehicle type	Material	Surface
9-146410	■ closed end	290	8	7		CuZn	Ni
9-147610	■ open end	300	8	7		CuZn	Ni
9-147615	■ open end	300	9	8		CuZn	Ni

ACCESSORIES

Service station dual foot air chucks



CLOSED END - Green handle

Self-closing after removal from tire valve

OPEN END - Black handle

Permanently open after removal from the tire valve

Spare parts

Art. no.	Description	Material	Surface
9-146010	Chuck nut (motor vehicle side)	CuZn	Ni
9-148010	Chuck nut (bicycle side)	CuZn	Ni
9-146020	Deflator pin (motor vehicle side - closed end)	CuZn	-
9-148020	Deflator pin (combined version - closed end)	CuZn	-
9-147120	Double deflator pin (open end)	CuZn	-
9-032114	Steel pressure spring (closed end)	Fe	-
9-030709	Replacement seal (motor vehicle side)	Rubber	-
9-030723	Replacement seal (combined version)	Rubber	-

CAR - OPEN END



CAR - CLOSED END



COMBINED VERSION - CLOSED END*



* 9-148100, 9-148200

GATOR INFLATOR

CALIBRATED, FOR THE PERFECT AIR PRESSURE!



PRECISE

- Calibrated manometer
- Reliable measurement results
- Precise processing

PRACTICAL

- Flexible hose
- Easy handling due to operating lever

VERSATILE

- Various hose lengths
- Valve adapter for all common connector variants

TIRE INFLATORS

Precise, practical, versatile

- Measuring range pressure: 0 - 12 bar / 0 - 175 psi
- Measurable medium: Air, nitrogen
- Hose length and plug: 0.5 m & clip-on air chuck*
- Connection thread: Quick coupling 3/8 inch



Gator Inflator

Art. no.	Description	Connection	Hose length	Calibrated	Operating temperature (°C)	Measuring range (bar)	Weight (g)
9-149946	MID	1	0,5 m	✓	-20 / +55	0-12	730
9-149945	MID	1	1,0 m	✓	-20 / +55	0-12	730
9-149944	MID	1	1,5 m	✓	-20 / +55	0-12	730
9-149951	MID*	2	1,0 m	✓	-20 / +55	0-12	730
9-149950	MID*	2	1,5 m	✓	-20 / +55	0-12	730
9-149948	MID*	3	1,0 m	✓	-20 / +55	0-12	730
9-149947	MID*	3	1,5 m	✓	-20 / +55	0-12	730
9-149971	MID DIN EN 12645*	1	1,5 m	calibrateable	-20 / +55	0-12	730
9-149955	MAX*	1	0,5 m	✓	-20 / +55	0-12	800

* Other hose lengths & valve connectors available upon request

GATOR INFLATOR SPARE HOSES (rotatable)



With Service station dual foot air chuck

Art. no.	Length (mm)
9-190006	500
9-190005	1000
9-190004	1500



With Thumb-lock air chuck

Art. no.	Length (mm)
9-190009	500
9-190008	1000
9-190007	1500
9-190014	3000
9-190016	6000



With Clip-on air chuck

Art. no.	Length (mm)
9-190011	500
9-190012	1000
9-190010	1500
9-190017	3000

ROTATABLE TIRE FILLER AND HOSES



Rotatable tire filler

Art. no.	Description	Vehicle type
9-149980	Rotatable tire inflator with quick coupling	*
9-149979	Rotatable tire inflator with quick coupling (Switzerland)	



Tire inflation hose with tire inflation manometer

Art. no.	Hose length
9-286188	1.5 m with clip-on air chuck and 18.5 m with wing nut M16x1.5

Tire inflation hose with clip-on air chuck



Art. no.	Hose length
9-281845	12 m with wing nut M16x1.5

Tire inflation hose with service station dual foot air chuck



Art. no.	Hose length
9-289760	15 m with wing nut M16x1.5

Wing nut M16x1.5



Art. no.	Length (mm)	Connector diameter (mm)	Hose inner diameter (mm)	Material	Surface
9-158000	31	6	5	CuZn	Ni
9-158200	31	7	6	CuZn	Ni
9-158300	31	8	7	CuZn	Ni
9-158100	31	9	8	CuZn	Ni

Wing nut M16x1.5 with long thread



Art. no.	Length (mm)	Connector diameter (mm)	Hose inner diameter (mm)	Material	Surface
9-158700	37	7	6	CuZn	Ni
9-158600	43			CuZn	Ni

Spare part for wing nut



Art. no.	Description	Material
9-041602	Replacement seal	Rubber

SCREW IN VALVES

ALLIGATOR special application

CONTENT

Screw in valves 162

Rim ferrule 165



SCREW IN VALVES

Special application



Thread connection 1/4"-18NPTF

Art. no.	Length (mm)	Wrench size	Filling side	Material	Surface	Valve caps
9-901003	33	14	car (8V1)	CuZn	-	



9-900501 9-900511

Thread connection 1/8"-27NPT

Art. no.	Length (mm)	Wrench size	Filling side	Material	Surface	Valve caps
9-900501	33	11	car (8V1)	CuZn	-	
9-900511	33	11	car (8V1)	CuZn	Ni	*



9-254501 9-254511 9-902001 9-902003

Thread connection G1/4

Art. no.	Length (mm)	Wrench size	Filling side	Material	Surface	Valve caps
9-254501*	33	22	car (8V1)	CuZn	-	
9-254511**	33	22	car (8V1)	CuZn	-	
9-902001	35	14	car (8V1)	CuZn	-	*
9-902003	35	14	car (8V1)	CuZn	-	*

* with sealing ring

** with sealing ring, without valve core



9-900883 9-901503

Thread connection G1/8

Art. no.	Length (mm)	Wrench size	Filling side	Material	Surface	Valve caps
9-900883	23	11	car (8V1)	CuZn	Ni	*
9-901503	33	14	car (8V1)	CuZn	-	*



Thread connection M8

Art. no.	Length (mm)	Wrench size	Filling side	Material	Surface	Valve caps
9-254201*	36	12	car (8V1)	CuZn	-	



Thread connection M8x1

Art. no.	Length (mm)	Wrench size	Filling side	Material	Surface	Valve caps
9-900843	18	10	car (8V1)	CuZn	Ni	
9-900845*	18	10	car (8V1)	CuZn	Ni	
9-900846*	18	10	car (8V1)	CuZn	Ni	
9-900863	21	12	car (8V1)	CuZn	Ni	

* with sealing ring



Thread connection M10x1

Art. no.	Length (mm)	Wrench size	Filling side	Material	Surface	Valve caps
9-902323	20	11	car (8V1)	CuZn	Ni	
9-902113	23	10	car (8V1)	CuZn	-	

RIM FERRULE

Accessories for rubber base valves

- **Application:** Required when tube valve TR13 is used for 15.7 valve hole.
- **Note:** Never use the ferrule in conjunction with rim valves (snap-in) and tubeless tires.

Rim ferrule TR13/TR15











Art. no.	TR no.	Material	Surface
9-049200	B6	Plastic	-

PART NUMBERS

9-799724.....	48	9-522099.....	31	9-095554.....	42	9-771544.....	56	9-731701.....	66	9-370023.....	72	9-534043.....	80	9-340441.....	92
9-790524.....	48	9-522445.....	31	9-521214.....	42	9-771550.....	56	9-731723.....	66	9-370028.....	72	9-542503.....	80	9-340501.....	92
9-771083.....	61	9-523018.....	31	9-530020.....	43	9-771555.....	56	9-732213.....	66	9-370038.....	72	9-594012.....	80	9-340541.....	92
9-731613.....	65	9-523036.....	31	9-530021.....	43	9-750603.....	57	9-732253.....	66	9-370163.....	72	9-544501.....	81	9-350641.....	93
9-149945.....	157	9-523099.....	31	9-530030.....	43	9-750701.....	57	9-733203.....	66	9-370168.....	72	9-544503.....	81	9-350661.....	93
9-149944.....	157	9-523131.....	31	9-530031.....	43	9-751101.....	57	9-733303.....	66	9-370183.....	72	9-544543.....	81	9-350721.....	93
9-149951.....	157	9-523445.....	31	9-530040.....	43	9-751103.....	57	9-733723.....	66	9-370188.....	72	9-545503.....	81	9-350771.....	93
9-149950.....	157	9-524145.....	31	9-530041.....	43	9-752803.....	57	9-734203.....	66	9-370198.....	72	9-546503.....	81	9-351071.....	93
9-149948.....	157	9-525018.....	31	9-530050.....	43	9-753303.....	57	9-734303.....	66	9-370223.....	72	9-547503.....	81	9-351171.....	93
9-149947.....	157	9-525445.....	31	9-530060.....	43	9-753603.....	57	9-735203.....	66	9-370228.....	72	9-322200.....	82	9-351241.....	93
9-149971.....	157	9-529445.....	31	9-031025.....	48	9-753803.....	57	9-735303.....	66	9-370248.....	72	9-322215.....	82	9-351411.....	93
9-190006.....	158	9-529900.....	33	9-799810.....	48	9-328501.....	59	9-735703.....	66	9-370253.....	72	9-324603.....	82	9-351641.....	93
9-190005.....	158	9-529902.....	33	9-799820.....	48	9-771153.....	59	9-735801.....	66	9-370288.....	72	9-324701.....	82	9-351871.....	93
9-190004.....	158	9-529904.....	33	9-799830.....	48	9-771154.....	59	9-735803.....	66	9-370328.....	72	9-324703.....	82	9-352171.....	93
9-190009.....	158	9-529910.....	33	9-799840.....	48	9-771163.....	59	9-736343.....	66	9-370388.....	72	9-033365.....	83	9-352421.....	93
9-190008.....	158	9-529912.....	33	9-799924.....	48	9-771170.....	59	9-736353.....	66	9-370408.....	72	9-339002.....	83	9-352711.....	93
9-190007.....	158	9-529914.....	33	9-799926.....	48	9-771183.....	59	9-736703.....	66	9-370428.....	72	9-339051.....	83	9-352801.....	93
9-190014.....	158	9-529920.....	33	9-799998.....	48	9-771243.....	59	9-736803.....	66	9-370438.....	72	9-339091.....	83	9-290090.....	94
9-190016.....	158	9-529922.....	33	9-770503.....	51	9-771253.....	59	9-030754.....	67	9-370440.....	72	9-339101.....	83	9-350671.....	94
9-190011.....	158	9-529924.....	33	9-770630.....	51	9-771283.....	59	9-701601.....	67	9-320000.....	73	9-339181.....	83	9-351242.....	94
9-190012.....	158	9-529930.....	33	9-770633.....	51	9-771783.....	59	9-703101.....	67	9-336507.....	73	9-339182.....	83	9-351971.....	94
9-190010.....	158	9-529932.....	33	9-773016.....	51	9-770723.....	61	9-710101.....	67	9-378578.....	73	9-339251.....	83	9-352071.....	94
9-190017.....	158	9-529934.....	33	9-770625.....	52	9-770733.....	61	9-710601.....	67	9-378638.....	73	9-820061.....	88	9-352422.....	94
9-590923.....	11	9-529950.....	33	9-770643.....	52	9-770973.....	61	9-711601.....	67	9-378688.....	73	9-820141.....	88	9-356070.....	94
9-590924.....	11	9-529954.....	33	9-770646.....	52	9-770993.....	61	9-712601.....	67	9-378798.....	73	9-820146.....	88	9-033245.....	95
9-590925.....	11	9-512512.....	36	9-770704.....	52	9-771033.....	61	9-712701.....	67	9-378868.....	73	9-820161.....	88	9-304000.....	95
9-590926.....	11	9-512514.....	36	9-773513.....	52	9-771043.....	61	9-381504.....	70	9-333008.....	74	9-820166.....	88	9-304500.....	95
9-590939.....	12	9-512573.....	36	9-773553.....	52	9-771093.....	61	9-381805.....	70	9-333068.....	74	9-820171.....	88	9-305000.....	95
9-590940.....	12	9-512583.....	36	9-770103.....	53	9-770773.....	63	9-382405.....	70	9-333108.....	74	9-820176.....	88	9-319900.....	95
9-030000.....	14	9-512593.....	36	9-770223.....	53	9-770863.....	63	9-382435.....	70	9-333208.....	74	9-820191.....	88	9-142700.....	96
9-590904.....	14	9-511983.....	37	9-770233.....	53	9-770883.....	63	9-382465.....	70	9-333268.....	74	9-030739.....	89	9-142800.....	96
9-590906.....	14	9-512462.....	37	9-770273.....	53	9-770933.....	63	9-382604.....	70	9-333308.....	74	9-329201.....	89	9-143400.....	96
9-590908.....	14	9-512503.....	37	9-770283.....	53	9-770943.....	63	9-382607.....	70	9-333328.....	74	9-820201.....	89	9-338501.....	96
9-590914.....	14	9-512507.....	37	9-770303.....	53	9-770963.....	63	9-382705.....	70	9-333408.....	74	9-820226.....	89	9-338601.....	96
9-590916.....	15	9-512553.....	37	9-770333.....	53	9-030753.....	65	9-382804.....	70	9-333508.....	74	9-820236.....	89	9-230700.....	97
9-590918.....	15	9-512563.....	37	9-770583.....	53	9-730163.....	65	9-382807.....	70	9-333708.....	74	9-820261.....	89	9-447413.....	100
9-590961.....	16	9-512628.....	37	9-774117.....	53	9-730173.....	65	9-382904.....	70	9-333808.....	74	9-820266.....	89	9-447500.....	100
9-590965.....	16	9-513003.....	37	9-774213.....	53	9-730603.....	65	9-382907.....	70	9-333908.....	74	9-820286.....	89	9-447505.....	100
9-591061.....	16	9-513103.....	37	9-097738.....	54	9-730613.....	65	9-383005.....	70	9-371198.....	74	9-820341.....	89	9-447513.....	100
9-591122.....	16	9-513143.....	37	9-097745.....	54	9-730623.....	65	9-330903.....	71	9-331468.....	75	9-820381.....	89	9-511003.....	100
9-591123.....	16	9-516023.....	37	9-097755.....	54	9-731103.....	65	9-330905.....	71	9-336108.....	75	9-830061.....	90	9-511992.....	100
9-591124.....	16	9-512558.....	38	9-770669.....	54	9-731601.....	65	9-330935.....	71	9-336408.....	75	9-830146.....	90	9-511993.....	100
9-590919.....	17	9-512568.....	38	9-770695.....	54	9-731603.....	65	9-331103.....	71	9-336508.....	75	9-830161.....	90	9-321800.....	101
9-590933.....	17	9-513043.....	38	9-770699.....	54	9-732301.....	65	9-331203.....	71	9-336509.....	75	9-830166.....	90	9-410503.....	101
9-590938.....	17	9-515003.....	38	9-097739.....	55	9-732303.....	65	9-331303.....	71	9-338258.....	75	9-830176.....	90	9-440003.....	101
9-030229.....	18	9-519003.....	38	9-097747.....	55	9-733101.....	65	9-331353.....	71	9-320000.....	76	9-830236.....	90	9-520944.....	102
9-590922.....	19	9-590046.....	38	9-097748.....	55	9-733103.....	65	9-331403.....	71	9-333006.....	76	9-830261.....	90	9-521515.....	102
9-520542.....	31	9-030731.....	39	9-097752.....	55	9-734101.....	65	9-331703.....	71	9-337501.....	76	9-830266.....	90	9-521527.....	102
9-521515.....	31	9-323020.....	39	9-770686.....	55	9-734103.....	65	9-332003.....	71	9-333206.....	76	9-850121.....	91	9-521545.....	102
9-521520.....	31	9-511003.....	39	9-770696.....	55	9-735101.....	65	9-332603.....	71	9-333306.....	76	9-850131.....	91	9-445011.....	103
9-521527.....	31	9-511992.....	39	9-770697.....	55	9-735103.....	65	9-332703.....	71	9-333406.....	76	9-850154.....	91	9-447512.....	103
9-521545.....	31	9-511993.....	39	9-779677.....	55	9-735601.....	65	9-332883.....	71	9-333506.....	76	9-850167.....	91	9-447515.....	103
9-522018.....	31	9-594150.....	39	9-771510.....	56	9-735603.....	65	9-332903.....	71	9-337501.....	76	9-850191.....	91	9-110000.....	107
9-522032.....	31	9-512013.....	40	9-771515.....	56	9-736101.....	65	9-370008.....	72	9-377700.....	76	9-340241.....	92	9-110001.....	107
9-522036.....	31	9-516103.....	40	9-771520.....	56	9-736103.....	65	9-370013.....	72	9-377702.....	76	9-340331.....	92	9-110002.....	107
9-522070.....	31	9-095519.....	42	9-771530.....	56	9-736601.....	65	9-370018.....	72	9-377710.....	76	9-340401.....	92	9-110010.....	107











Vehicles

	motorcycle
	scooter
	bicycle
	car
	van
	truck
	tractor
	earthmover (EM)











Norms

TR	Tire and Rim Association (US)
ETRTO	European Tyre and Rim Technical Organisation

Material

	brass
	aluminum
	steel
	rubber
	plastic
	nickel-plated
	anodized
	zinc-plated
	chrome-plated

Features

	round top valve cap
	long round top valve cap
	plastic valve cap with sealing
	plastic valve cap without sealing
	hexagonal valve cap
	screw driver valve cap
	plastic valve extension cap
	metal valve extension cap
	DS-P valve cap
	V2B valve cap
	hexagon nut
	external hexagon valve base
	highlight flag



ALLIGATOR is a brand
of WEGMANN automotive.

WEGMANN automotive GmbH

Rudolf-Diesel-Straße 6
97209 Veitshöchheim
GERMANY

Phone: +49 (0) 931 321 04 0
E-Mail: info@wegmann-automotive.de

www.alligator-valves.com

